

# 外形图 Mechanical Dimensions

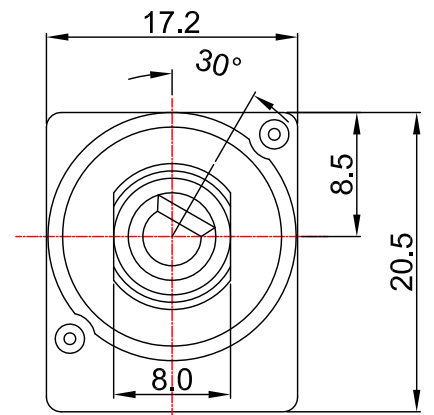

Shaft shown in full C.C.W. position

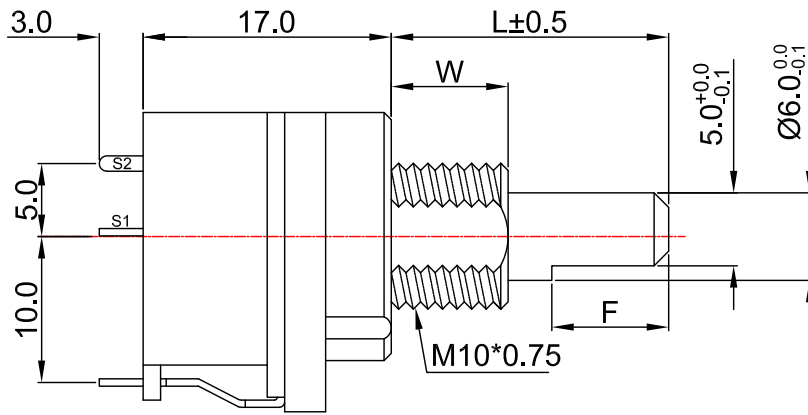
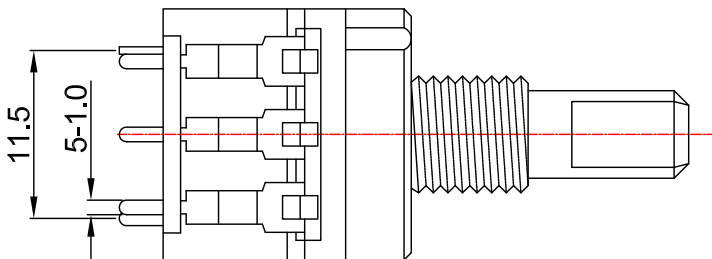

接线图  
Circuit explanation

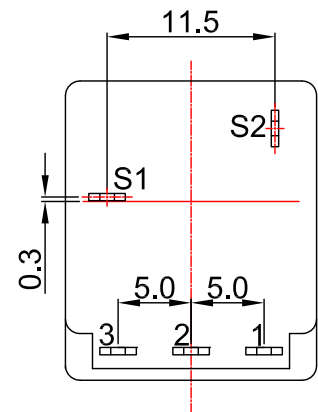

安装孔位置图  
P.C.B. mounting hole detail

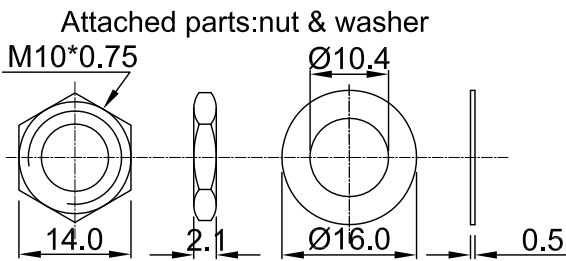
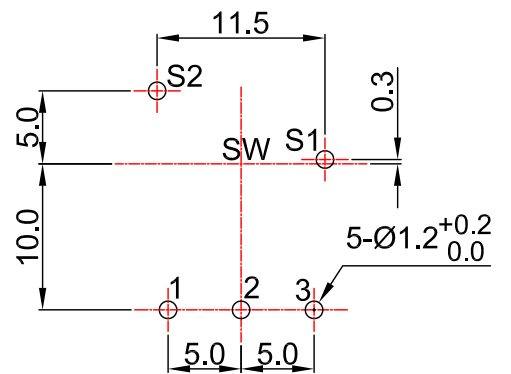
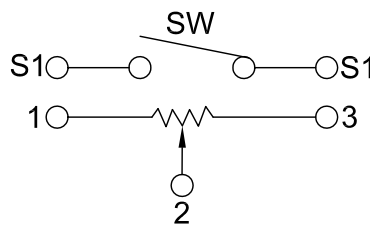

F type plastic shaft

L	17	19	34	37
F	8.0			
w	8.0			

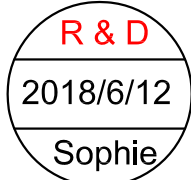

3				PRODUCT NAME	Switch Rotary Potentiometer		
2				MODEL NAME	R16R2S- <sup>shaft</sup> L D1-value		
1				APPROVED BY	CHECKED BY	DRAWN BY	
NO	DATE	DESCRIPTION					
DIMENSION		TOLERANCE	SCALE				
∫ ≤ 10		± 0.2	UNIT				
10 < ∫ ≤ 30		± 0.5	VER.				A0
30 < ∫ ≤ 100		± 1.0	DATE				2018/4/11
All Angles		± 5°					

# 16 mm Rotary Potentiometers with SW series Specifications

1.電氣性能 (Electrical Characteristics)					
1.1	全阻抗值 (Total Resistance)		1KΩ ~ 2MΩ		
1.2	全阻抗值允許偏差 (Total Resistance Tolerance)		±20% ( More than 1 M Ω ±30%)		
1.3	電阻隨溫度變化特性 (Resistance of temperature change character)		20°C-75°C:ΔR/R≤±5%, -25°C-20°C:ΔR/R≤±4.5%		
1.4	阻值變化特性 (Resistance Taper)		A, B		
1.5	零位阻值 (Residual Resistance)		R≥250KΩ / 0.1 % max. of total Value 250KΩ>R>10KΩ / 20Ω max. 10KΩ≥R / 10Ω max.		
1.6	額定功率 (Rated Power)		Linear Taper B: 0.5W Other Taper:0.2W		
1.7	最高使用電壓 (Max.Operating Voltage)		250VAC		
1.8	動雜音 (Rotational Noise)		Less Than 100mV		
1.9	絕緣阻抗 (Insulation Resistance)		More than 100MΩ at DC 250V		
1.10	耐電壓 (Withstand Voltage)		For 1 minute at: DC 500V		
1.11	开关額定功率(Switch Rated Power)		250VAC , 10A		
2.機械性能 (Mechanical Characteristics)					
2.1	全回轉角度 (Rotation Angle)		300°±5°		
2.2	旋轉力矩 (Rotation Torque)		10~100gf.cm		
2.3	軸的拉、押強度 (Pull-Push Strength)		3.5 Kgf.cm		
2.4	轉動止檔強度 (Rotational Stop-End Torque)		5 kgf.cm Min		
2.5	开关角度(Switch Working Angel)		50°±10°		
2.6	开关力矩(Switch Working Torque)		50~150gf.cm		
2.7	旋轉定位數目 (Number of Detents(click))		0 detents / 16 detents /30 detents		
2.8	焊錫耐熱性 (Resistance To Soldering Heat)		260±5°C and less than 3 seconds		
3.耐久性能 (Durability)					
3.1	回轉壽命 (Rotation Life)		10,000 Cycles min.		
3.2	工作溫度 (Operating temperature)		-10°C~+70°C		
4.1	外形尺寸圖/曲線特性圖 (Shape size drawing/curve characteristic drawing)		見附頁 Please refer the drawing		
批 准			審 核		
			設 計		

# RESISTANCE TAPER



### TAPER B SERIES

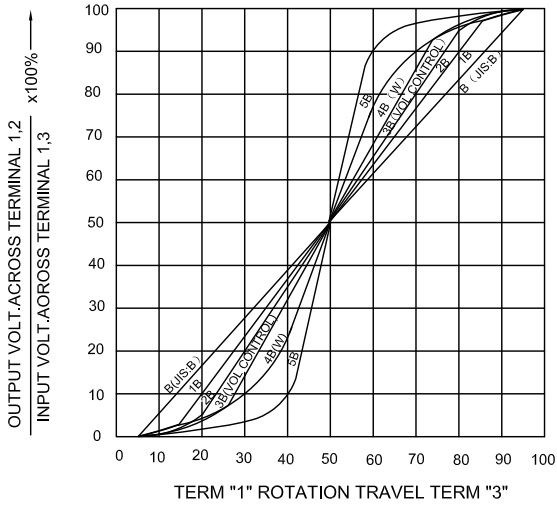

### TAPER B WITH 50% TAP

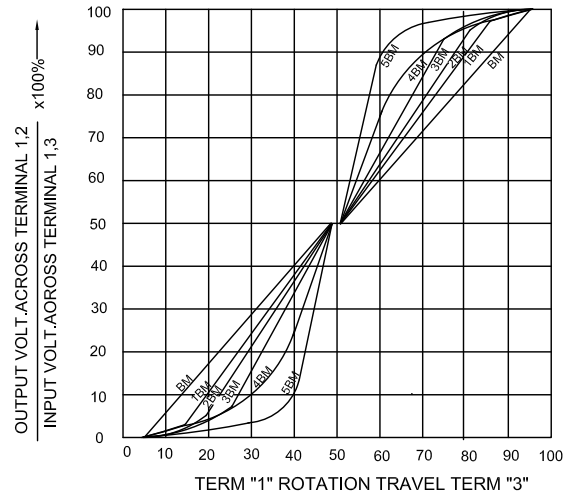

### TAPER A SERIES

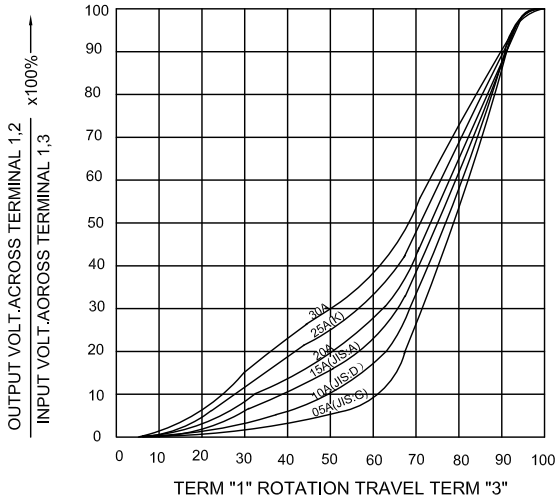

### TAPER A & C WITH 50% TAP

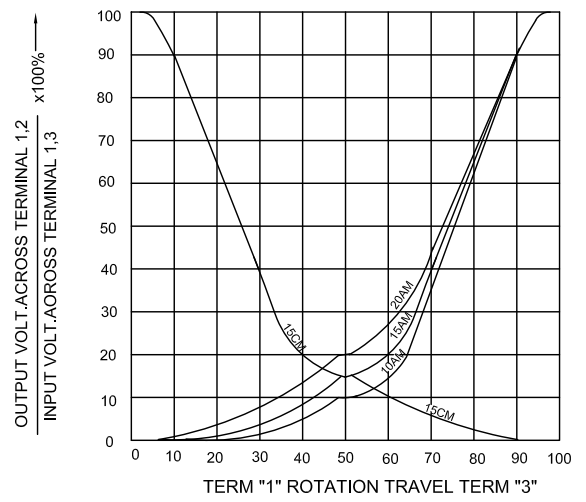

### TAPER C SERIES

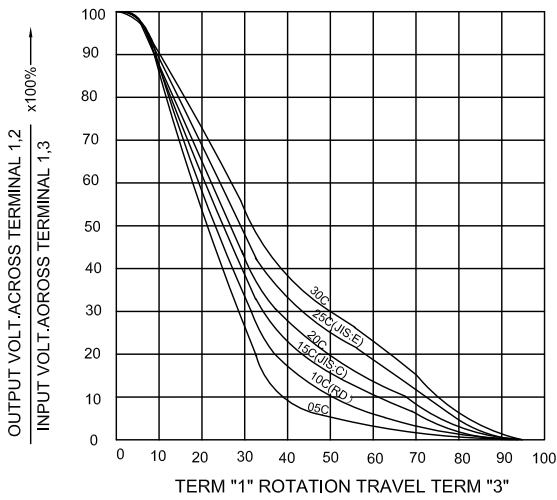

### TAPER M & N SERIES

