

# 外形图 Mechanical Dimensions

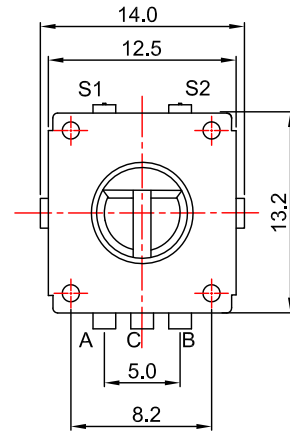

输出信号  
Output signal format

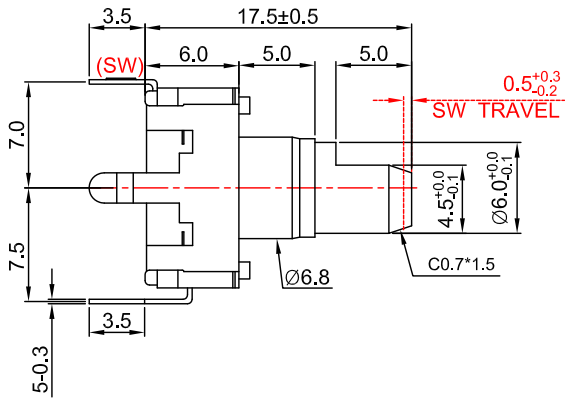
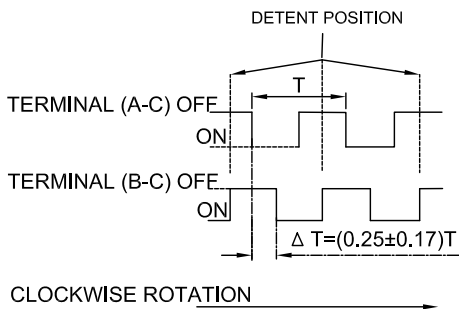

接线图  
Circuit explanation

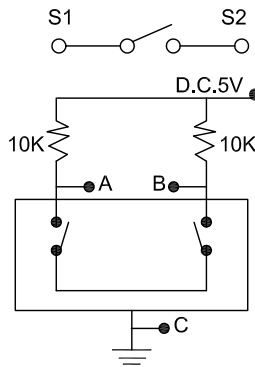

安装孔位图  
P.C.B. mounting hole detail

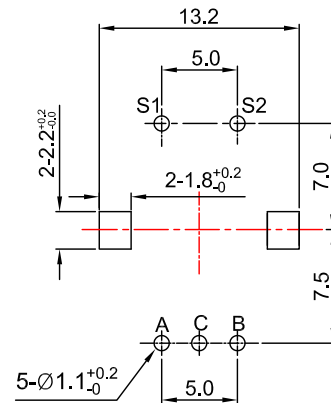

● Detent & Pulse type

Y	Detent	PULSE
24C24P	24	24
24C12P	24	12
12C12P	12	12

3			PRODUCT NAME	Switch Encoder		
2			MODEL NAME	R121ECS-17.5F5D1-C-P		
1			APPROVED BY	CHECKED BY	DRAWN BY	
NO	DATE	DESCRIPTION				
DIMENSION	TOLERANCE	SCALE				
$\int \leq 10$	$\pm 0.2$	UNIT	mm			
$10 < \int \leq 30$	$\pm 0.5$	VER.	A0			
$30 < \int \leq 100$	$\pm 1.0$	DATE	2015-4-15			
All Angles	$\pm 5^\circ$					

# R12EC SERIES SPECIFICATION R12EC系列规格书

## 1. 一般事项 General

### 1-1. 适用规格 Scope

本规格适用于微小电流回路的电子设备,属11型回转编码器.

This specification applies to 11 mm size low-profile rotary encoder (incremental type) for microscopic current circuits, used in electronic equipment.

### 1-2. 标准状态 Standard atmospheric conditions

除另有规定外,测量应在以下状态下进行:

Unless otherwise specified, the standard range of atmospheric conditions for making measurements

and test is as following limits:

温度 Ambient temperature: 15°C to 35°C

相对湿度 Relative humidity: 25% to 85%

气压 Air pressure: 86kpa to 106kpa

### 1-3. 使用温度范围

Operating temperature range: -10°C to 70°C

### 1-4. 保存温度范围

Storage temperature range: -40°C to +85°C



图1

## 2. 构造 Construction

### 2-1. 尺寸 Dimensions

见所附成品图 Refer to attached drawing

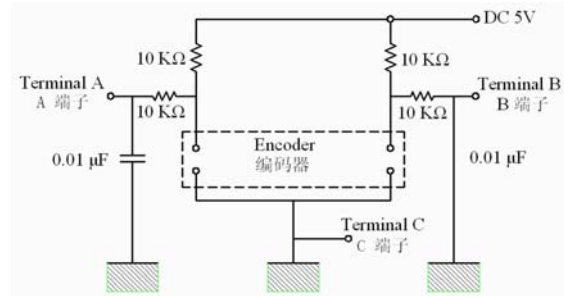
## 3. 额定值 Rating

### 3-1. 额定电压

Rated voltage: DC 5V

### 3-2. 最大额定电流(阻抗负载)

Maximum operating current (resistive load)

各相导线 Each lead: 1mA

## 4. Application Nots 使用上的事项

### 4-1. 避免储藏于高温、潮湿及腐蚀的场所. 产品购入后尽可能在6个月内使用完. 拆包装后未使用完的剩余产品需储藏于防潮防毒的环境下.

Avoid storing the products in a place at high temperature, high humidity and in Corrosive gases. Please use this product as soon as possible with 6 months limitation. If any remainder left after packing is opened, please store it with proper moistureproofing, gasproofing etc.

### 4-2. 编码器信号的计算方法应将操作的速度,信号的取样时间及电子回路中的微电脑软件等考虑进去.

The encoder pulses count method should be designed with taking operating speed, sampling time and design of the microcomputer software into consideration.

### 4-3. 此产品在定位点的输出阻抗波形参照(5-1),因此在设计软体时请留意其状态.

With this products the detent position output conslt fig.5-1. Therefore make the A phase the reference at the soft ware design stage.

### 4-4. 在设计时要考虑到杂讯,建议使用C/R滤波电路,(图1)

At design of the pulse count process. Using the C/R filter circuit is Recommended (fig.1)

### 4-5. 本产品请勿碰触到水,可能会导致输出波形的异常.

Care must be taken not to expose this product to water or dew to prevent possible problem in pluses output waveform

R12EC SERIES SPECIFICATION R12EC系列规格书

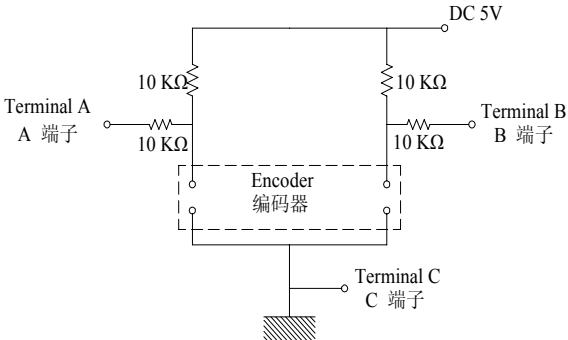
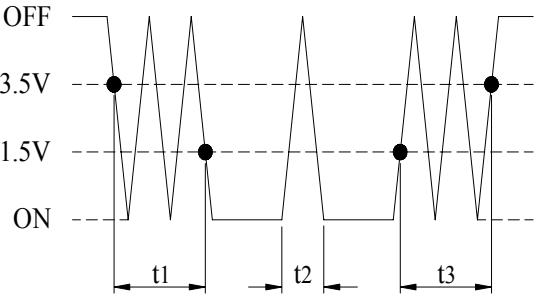
5.电气性能 ELECTRICAL CHARACTERISTICS				
项目 ITEM	条件 CONDITIONS		规格 SPECIFICATIONS	
5-1.输出信号 Output signal format	A、B两信号输出相位差, 输出波形详细见(图2/3)(虚线表示带卡点装置的上擎子处位置) 2 phase different signals (signal A, signal B) Details shown in <fig.2/3> (the broken line shows detent position.)			
	轴回转方向 Shaft rotational direction	信号 Signal	输出波形 Output	
	顺时针方向 C.W	(A-C端子间) A(Terminal A-C) B(B-C端子间) B(Terminal B-C)	图2 fig. 2	图3 fig. 3
		逆时针方向 C.C.W	A(A-C端子间) A(Terminal A-C) B(B-C端子间) B(Terminal B-C)	
5-2. 分解能力 Resolution	回转360°的输出脉冲数. Number of pulses in 360° rotation.		<input type="checkbox"/> 14个脉冲/360° (图2) 14Pulsrs/360° (fig2) for each phase <input checked="" type="checkbox"/> 26个脉冲/360° (图3) 24Pulsrs/360° (fig3) for each phase	
5-3.开关特性 Switching characteristics	下(图4)所示回路,轴以360° /sec 的速度转动测定。 Measurement shall be made under the condition as follows . Shaft rotational speed : 360° /S Test circuit : (fig .4) 图4<fig .4>			
			图5<fig .5> 	
	(注) 编码 OFF 指输出电压3.5V以上的状态(fig.5). Code-OFF area :The area which the voltage is 3.5V or more(fig.5) 编码 ON 指输出电压1.5V以下的状态(fig.5). Code ON area :The area which the voltage is 3.5V or more(fig.5) .			
5-3-1.振荡 Chattering	编码从OFF→ON或ON→OFF时,输出1.5V~3.5V的通过时间应符合规定。 Specified by the signal's passage time from 1.5V to 3.5V of each switching position (code OFF~ON or ON ~OFF)		t1, t3 ≤ 5ms	
5-3-2.滑动杂音 (突跳) Sliding noise (Bounce)	编码 ON 部份的1.5V以上的电压变动时间在振荡t1,t3之间会产生1ms以上,1.5V以下的 ON 部份.另外,如果各突跳间1.5V以下的范围在1ms以上时,则判定为另一个突跳。 Specified by the time of voltage change exceed 1.5V in code-ON area.when the bounce has code -ON time less than 1ms between chattering (t1 or t3),the voltage change shall be regarded as a part of chattering.when the code-ON time between 2 bounces is less than 1ms .they are regarded as 1 linked bounce		t2 ≤ 5ms	
5-3-3.滑动噪音 Sliding noise	编码OFF部份的电压变动。 The voltage change in code-OFF area.		3.5 V 以上 3.5 V min	

## R12EC SERIES SPECIFICATION R12EC系列规格书

5. 电气性能 ELECTRICAL CHARACTERISTICS		
项目 ITEM	条件 CONDITIONS	规格 SPECIFICATIONS
5-4. 相差 Phase difference	<p>下(图6)所示回路,轴以360° /S的速度转动测定。 Measurement shall be made under the condition which the shaft is rotated at 60r /min</p> <p style="text-align: right;">图6 fig.6</p> <p>A信号(A~C)间 signal A</p> <p>B信号(B~C)间 signal B</p> <div style="text-align: center;"> </div>	<p><math>T_1, T_2, T_3, T_4 \geq 4\text{ms}</math> 见图6 (fig. 6)</p>
5-5. 绝缘阻抗 Insulation resistance	<p>在端子和轴间施加电压 250V DC。 Measurement shall be made under the condition which a voltage of 250V DC is applied between individual terminals and bushing .</p>	<p>100Ω 以上 100Ω Min</p>
5-6. 耐电压 Dielectric strength	<p>在端子和轴间施加 AC 300 V电压1分钟。 A voltage of 300V AC shall be applied for 1 minute between individual terminals and bushing.</p>	<p>不得有绝缘破坏 Without arcing or breakdown</p>
5-7. 端子间接触阻抗 Contact resistance	<p>出力信号处于 ON 时安定状态条件下测定。 Measurement shall be stable condition which a output signal is ON.</p>	<p>1Ω 以下 1Ω Max</p>
6. 机械性能 Mechanical characteristics		
6-1. 全回转角度 Total rotational angle		<p>360° (无止档点) 360° (End less)</p>
6-2. 定位点力矩 Detent torque	<p>只适用于附卡点装置 Only suitable for C.C, equipment.</p>	<p>3~20mN.m(30~200gf.cm) Shaft rotatable at -10°C~+5°C 但在-10°C~+5°C轴勉强可转动</p>
6-3. 定位点数及位置 Number of detent and position	<p>只适用于附卡点装置 Only suitable for C.C, equipment.</p>	<p>12detents (Step angle :12° ±2° ) 12点定位(间隔角度12° ±2° ) <input checked="" type="checkbox"/> 24detents(Step angle :18° ±2° ) <input type="checkbox"/> 24点定位(间隔角度18° ±2° )</p>
6-4. 轴的推拉强度 Push -pull strength of shaft	<p>在轴端,沿轴向施加 10Kg 的静负荷力推和拉各10秒钟 (产品焊锡固定在PCB上。) Push and pull static load of 10kg shall be applied to be shaft in the axial direction for 10s. (After soldering of the PC board)</p>	<p>轴无破损,回转无异常,电气性能无异常。 Without damage or excessive play in shaft.NO excessive abnormality in rotational feeling .And.electrical characteristics and be satisfied.</p>
6-5. 轴摆动 Shaft wobble	<p>在轴前端5mm处,沿径向瞬间施加 50mN.m (500gf.cm)的力。 A momentary load of 50mN.m (500gf.cm) shall be applied at the point 5mm from the tip of the shaft in a direction perpendicular to the axis of shaft.</p>	<p>0.8xL/30mm p-p以下(L:指安装平面到轴的柄端的距离) 0.8x1/30mm p-p Max或(l:Distance between mounting surface and measuring point on the shaft)</p>
6-6. 轴的回转方向 摆动 Shaft play in rotational wobble	<p>用角度板测定。 Testing by angle board.</p>	<p>5° 以下 5° MAX</p>

## R12EC SERIES SPECIFICATION R12EC系列规格书

7. 耐久性能 ENDURANCE CHARACTERISTICS		
项目 ITEM	条件 CONDITIONS	规格 SPECIFICATIONS
7-1. 回转寿命 Rotational life	<p>在无负荷条件下轴以 600周/小时速度回转30,000周。</p> <p>The shaft of encoder shall be rotated to 30,000 cycles at a speed of 600cycles/H without electrical load ,after with measurements shall be made.</p>	<p>端子间接触阻抗200Ω 以下。</p> <p>Contact resistance 200 Ω Max</p> <p>尚余有轻微定位感</p> <p>Vibration t1, t3≤5mS 振荡t1, t3 ≤5mS Bounce t2≤5mS 突跳 t2≤5mS Detent feeling has to remains</p>
7-2. 耐湿性 Damp heat	<p>温度40±2℃,湿度90~95%的恒温恒湿湿槽中放置48 小时后,在常温、常湿中放置1.5小时后测试。</p> <p>The encoder shall be stored at temperature of 40±2℃ with relative humidity of 90% to 95% for 48H in a thermostatic chamber.And the encoder shall be subjected to standard atmospheric conditions for 1.5H,After which measurements shall be made.</p>	<p>所有项应满足初期规格</p> <p>Specifications in clause all items is shall be satisfied .</p>
7-3. 耐热性 Dry heat	<p>温度80±3℃的恒温箱中放置48小时,然后在常温、常湿放置1.5小时后测试。</p> <p>The encoder shall be stored at a temperature of 80±3℃ for 48H in a thermostatic chamber.And the encoder shall be subjected to standard atmospheric conditions for 1.5H, After which measurements shall be made.</p>	<p>所有项应满足初期规格</p> <p>Specifications in clause all items is shall be satisfied .</p>
7-4. 低温特性 Cold	<p>温度-25±3℃的恒温箱中放置48小时,常温、常湿放置1.5小时后测试。</p> <p>The encoder shall be stored at a temperature of -25±3℃ for 48H in a thermostatic chamber.And then the encoder shall be subjected to standard atmospheric conditions for 1.5H.After which measurements shall be made.</p>	<p>所有项应满足初期规格</p> <p>Specications in clause all items is shall be satisfied .</p>
7-5. 焊锡性 Solder ability	<p>端子在260℃±5℃温度的焊锡槽内浸锡3秒±0.5秒。</p> <p>The terminals shall be immersed into solder bath at 260℃ for 3s±0.5s in the same manner as para.</p>	<p>浸渍面须有75%以上焊锡附着</p> <p>A new uniform coating of solder shall cover 75% minimum of the surface being immersed.</p>
7-6. 耐焊接热 Resistance to Soldering heat	<p>手工焊接 Manual soldering 温度300℃以下,时间3秒以内。 Bit temperature of soldering iron:300℃ less than application time of soldering iron :within 3s.</p> <p>槽焊 Dip soldering . 使用基板: t=1.6mm的单面覆铜板。 Printed wiring board :single -stded copper clad laminate board with thickness of 1.6mm.</p> <p>预热:基板表面温度100℃以下,时间1分钟以内。 Preheating:1.Surface temperature of board :100℃ or less 2.preheating time :within 1 min</p> <p>焊接:温度260±5℃或以下,时间3秒以内。 Soldering :Solder temperature:260±5℃ or less</p> <p>Immersion time :within 3s</p>	<p>不得有绝缘体的破坏、变形、接触无异常。</p> <p>Electrical characteristics shall be satisfied No mechanical abnormality.</p>

# R12EC SERIES SPECIFICATION R12EC系列规格书

## 推动开关部分 Push Switch Portion

备注:以下规格适用于R11ECS编码带开关系列.

No: The following specification is only suitable for the one type with switch construction of R11EC encoder series.

### 1. 额定值 Rating

1-1. 额定电压

Rated voltage :DC 5V

1-2. 最大额定电流(阻抗负载)

Maximum operating current (resistive load ):10mA MAX

### 2. 电气性能 ELECTRICAL CHARACTERISTICS

项目 ITEM	条件 CONDITIONS	规格 SPECIFICATIONS
2-1. 接触电阻 Contact resistance	用 DC 5V 1mA 电压测定. Voltage test at DC 5V 1mA.	100mΩ less ≤100mΩ
2-2. 绝缘阻抗 Insulation resistance	在端子和安装板间施加电压250V DC. Measurement shall be made under the condition which a voltage of 250V DC is applied between individual terminals and bushing and bushing and plank	100MΩ 以上 100MΩ Min
2-3. 振荡 Bouncing	以1秒钟1往返(OFF-ON-OFF)按压动作. Shaft shall be push at 1 cycles/s (OFF-ON-OFF)	10ms or less ≤10ms
2-4. 耐电压 Dielectric strength	在端子和安装板间施加AC300V电压1分钟 A voltage of 300V Ac shall be applied for 1 minute between individual terminals and bushing and plank.	不得有绝缘破坏 Without arcing or breakdown

### 3 机械性能 Mechanical characteristics

3-1. 开关电路.接点数 Switch circuit and number of pulse		单极单投(按压ON) Single pole and single throw (ON switch function )
3-2. 开关动作力 Operation fore of switch	在轴端,沿轴向施加的按压力. Push static load to the shaft in the axial direction.	Nil
3-3. 开关动移动量 Travel of switch		Nil

### 4 耐久性能 Endurance Characteristics

回转寿命 Rotaional life	The shaft of encoder shall be push to 20,000 cycles at a speed of 600 cycles/H without electrical load ,after with measurements shall be made.	接触电阻:≤200mΩ . 其它应满足初期规格. Contact resistance : 200mΩ or less Specifi cation in clause shall be satisfied.
------------------------	--	---

制定日期	2007-5-15	DSG.承办	CHKD.审核	APPD.批准	TITLE 标题: ENCODER 编码器 DOCUMENT No.文号: R12ECS
版本号: 00	变更记录				
		2009.06.04 Sam	2009.06.04 Sophie	2009.06.04 Jennifer	