

外形图 Mechanical Dimensions

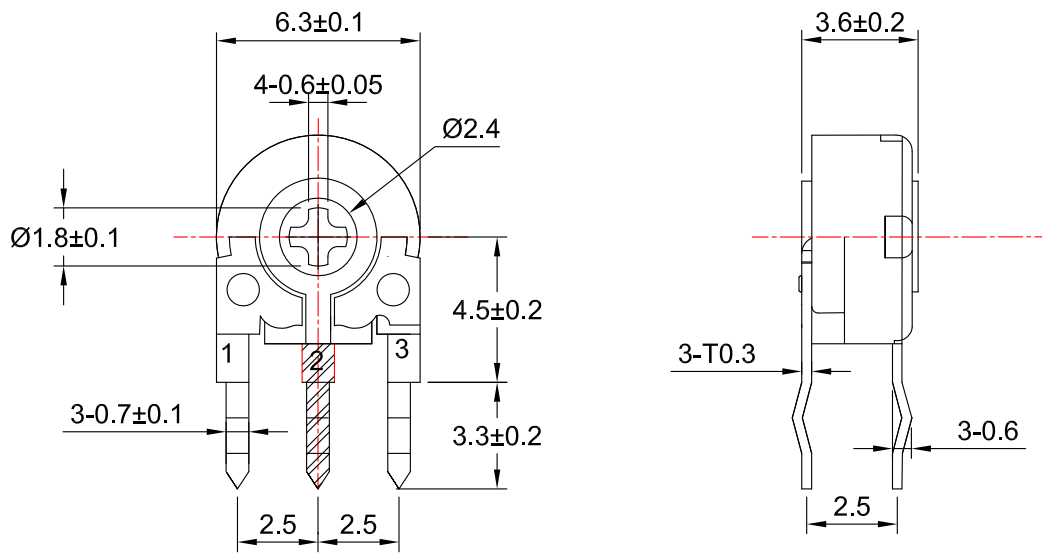

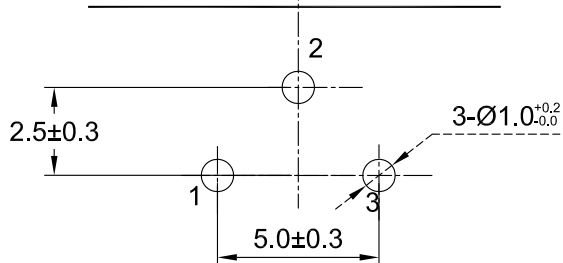

安装孔位图
P.C.B. mounting hole detail

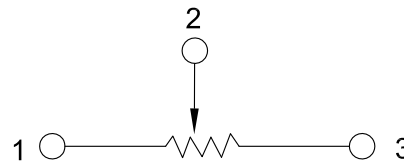

接线图
Circuit explanation

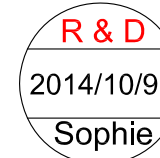

3			PRODUCT NAME		Semi-fixed Potentiometer		
2			MODEL NAME		SB063-1-value		
1			APPROVED BY		CHECKED BY		DRAWN BY
NO	DATE	DESCRIPTION					
		DIMENSION	TOLERANCE	SCALE			
		$\int \leq 10$	± 0.2	UNIT	mm		
		$10 < \int \leq 30$	± 0.5	VER.	A0		
		$30 < \int \leq 100$	± 1.0	DATE	2014/10/9		
		All Angles	$\pm 5^\circ$				
							

Semi-fix Potentiometers Series Specifications

1. 電氣性能 (Electrical Characteristics)					
1.1	全阻抗值 (Total Resistance)	1K Ω ~ 2M Ω			
1.2	全阻抗值允許偏差 (Total Resistance Tolerance)	$\pm 20\%$ (More than 1 M Ω $\pm 30\%$)			
1.3	電阻隨溫度變化特性 Resistance of temperature change character)	20 $^{\circ}$ C-75 $^{\circ}$ C: $\Delta R/R \leq \pm 5\%$, -25 $^{\circ}$ C-20 $^{\circ}$ C: $\Delta R/R \leq \pm 4.5\%$			
1.4	阻值變化特性 (Resistance Taper)	A, B			
1.5	零位阻值 (Residual Resistance)	R $\geq 250K\Omega$ / 0.1 % max. of total Value 250K Ω >R>10K Ω / 20 Ω max. 10K Ω >R / 10 Ω max.			
1.6	額定功率 (Rated Power)	Linear Taper B: 0.05W Other Taper:0.025W			
1.7	最高使用電壓 (Max.Operating Voltage)	50V DC			
1.10	耐電壓 (Withstand Voltage)	For 1 minute at: AC 500V			
1.8	耐溫特性 (Temperature Characteristic)	-10 $^{\circ}$ C ~ 70 $^{\circ}$ C: $\Delta R/R \leq \pm 8\%$			
1.9	潮濕環境下負載性能 (Load Life In Humidity)	20%Max 350 hours rated in 90%RH 40 $^{\circ}$ C			
2. 機械性能 (Mechanical Characteristics)					
2.1	全回轉角度 (Rotation Angle)	235 $^{\circ}$ $\pm 10^{\circ}$			
2.2	旋轉力矩 (Rotation Torque)	10~200gf.cm			
2.4	轉動止檔強度 (Rotational Stop-End Torque)	0.3 kgf.cm Max.			
2.8	焊錫耐熱性 (Resistance To Soldering Heat)	<u>260± 5^{\circ}C and less than <u>3</u> seconds</u>			
3. 耐久性能 (Durability)					
3.1	回轉壽命 (Rotation Life)	500 OR 10,000 Cycles min.			
3.2	工作溫度 (Operating temperature)	-10 $^{\circ}$ C ~ +70 $^{\circ}$ C			
4.1	外形尺寸圖/曲線特性圖 (Shape size drawing/curve characteristic drawing)	見附頁 Please refer the drawing			
批 准		審 核		設 計	

RESISTANCE TAPER

TAPER B SERIES

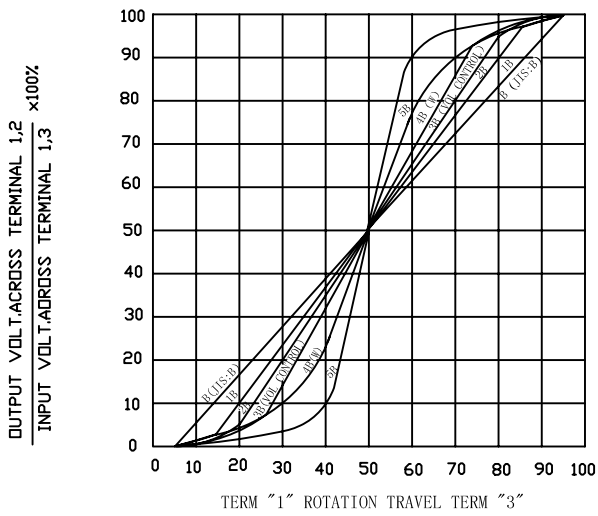

TAPER B WITH 50% TAP

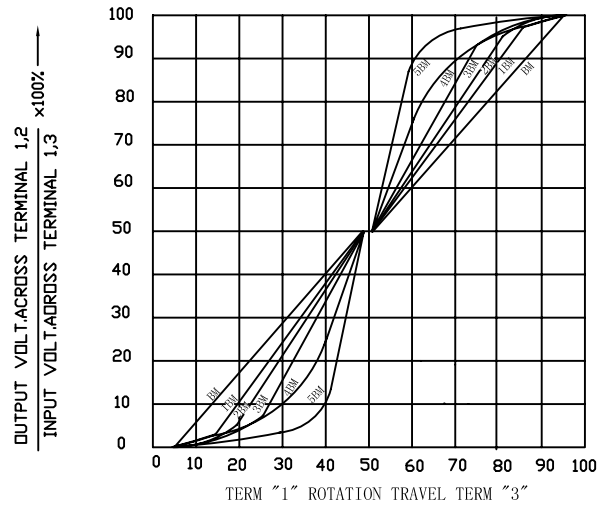

TAPER A SERIES

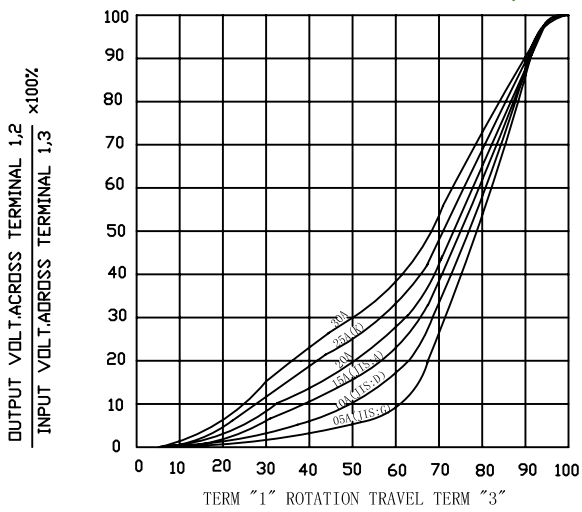

TAPER A & C WITH 50% TAP

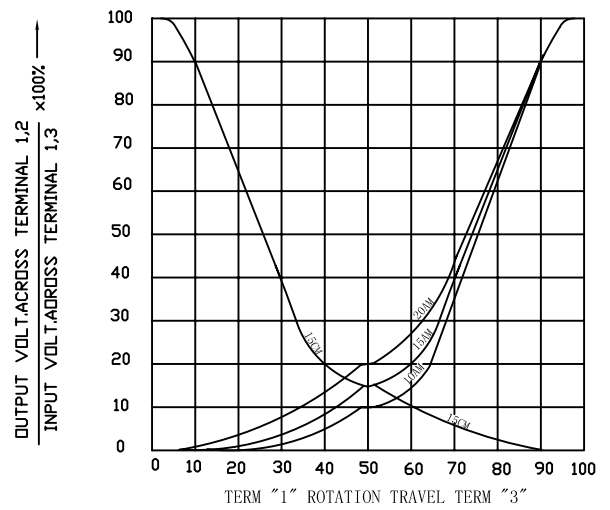

TAPER C SERIES

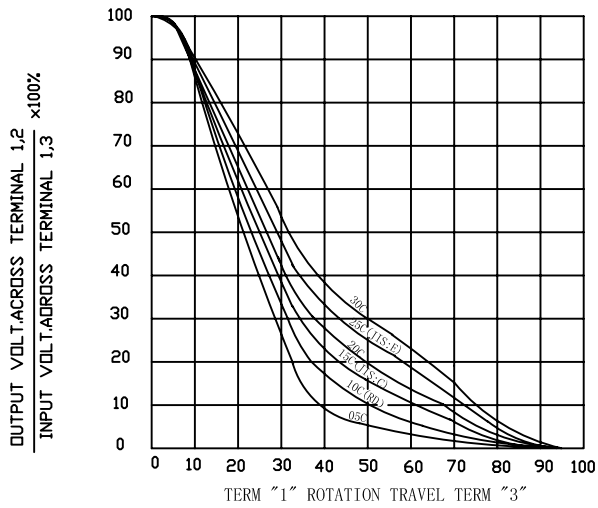

TAPER M & N SERIES

