

外形图 Mechanical Dimensions

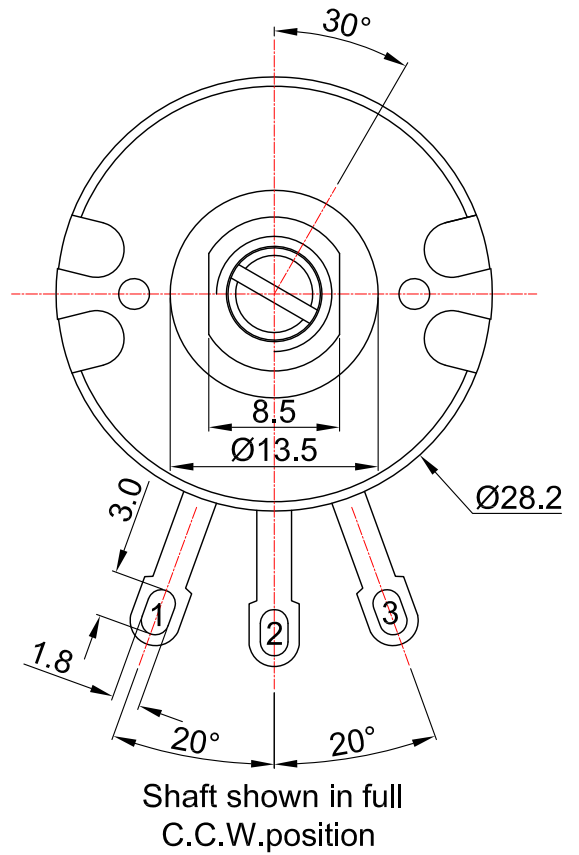

接线图
Circuit Explanation

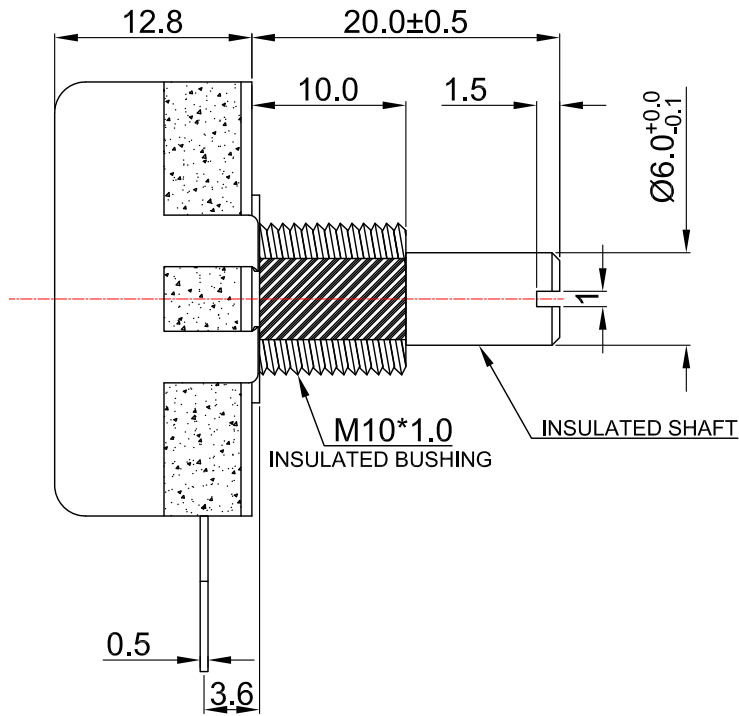

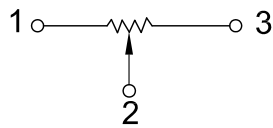

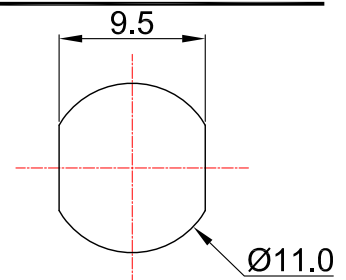
安装孔位置图
P.C.B. mounting hole detail



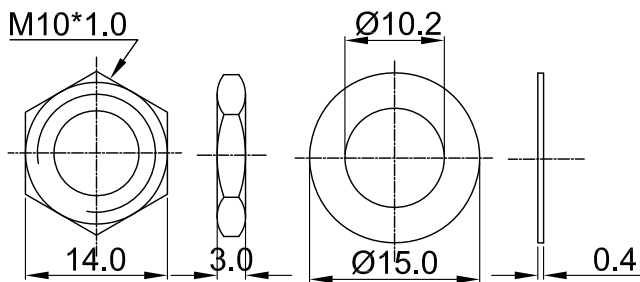

attached parts: nut & washer



3				PRODUCT NAME	Rotary Potentiometer		
2				MODEL NAME	RB28N-RA1-value-WZ-V46		
1				APPROVED BY	CHECKED BY	DRAWN BY	
NO	DATE	DESCRIPTION					
	DIMENSION	TOLERANCE	SCALE				
	$j \leq 10$	± 0.2	UNIT	mm			
	$10 < j \leq 30$	± 0.5	VER.	A0			
	$30 < j \leq 100$	± 1.0	DATE	2013/05/31			
	All Angles	$\pm 5^\circ$					

28 mm Rotary Potentiometers Series Specifications

1. 電氣性能 (Electrical Characteristics)					
1.1	全阻抗值 (Total Resistance)	1K Ω ~ 2M Ω			
1.2	全阻抗值允許偏差 (Total Resistance Tolerance)	$\pm 20\%$ (More than 1 M Ω $\pm 30\%$)			
1.3	電阻隨溫度變化特性 Resistance of temperature change character)	20 $^{\circ}$ C-75 $^{\circ}$ C: $\Delta R/R \leq \pm 5\%$, -25 $^{\circ}$ C-20 $^{\circ}$ C: $\Delta R/R \leq \pm 4.5\%$			
1.4	阻值變化特性 (Resistance Taper)	A, B, C, W			
1.5	零位阻值 (Residual Resistance)	R $\geq 250K\Omega$ / 0.1 % max. of total Value 250K Ω >R>10K Ω / 20 Ω max. 10K Ω \geq R / 10 Ω max.			
1.6	額定功率 (Rated Power)	Linear Taper B: 0.5W Other Taper:0.25W			
1.7	最高使用電壓 (Max.Operating Voltage)	250V AC			
1.8	動雜音 (Rotational Noise)	Less Than 47mV			
1.9	絕緣阻抗 (Insulation Resistance)	More than 100M Ω at DC 500V			
1.10	耐電壓 (Withstand Voltage)	For 1 minute at: AC 2000V			
1.11	开关額定功率(Switch Rated Power)	-----			
1.12	同步誤差 (Gang Error)	-----			
2. 機械性能 (Mechanical Characteristics)					
2.1	全回轉角度 (Rotation Angle)	300 $^{\circ}$ \pm 10 $^{\circ}$			
2.2	旋轉力矩 (Rotation Torque)	20~200gf.cm			
2.3	軸的拉、押強度 (Pull-Push Strength)	6 Kgf.cm			
2.4	轉動止檔強度 (Rotational Stop-End Torque)	5 kgf.cm Min			
2.5	开关角度(Switch Working Angel)	-----			
2.6	开关力矩(Switch Working Torque)	-----			
2.7	旋轉定位數目 (Number of Detents(click))	-----			
2.8	焊錫耐熱性 (Resistance To Soldering Heat)	<u>260\pm5$^{\circ}$C</u> and less than <u>3</u> seconds			
3. 耐久性能 (Durability)					
3.1	回轉壽命 (Rotation Life)	50,000 Cycles min.			
3.2	工作溫度 (Operating temperature)	-10 $^{\circ}$ C~+60 $^{\circ}$ C			
4.1	外形尺寸圖/曲線特性圖 (Shape size drawing/curve characteristic drawing)	見附頁 Please refer the drawing			
批准		審核		設計	

RESISTANCE TAPER



TAPER B SERIES

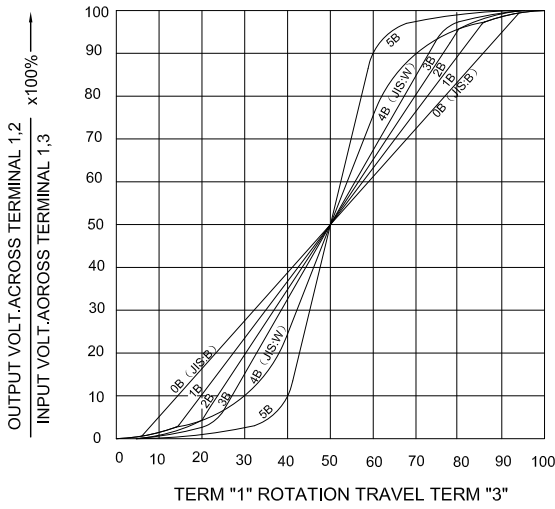

TAPER B WITH 50% TAP

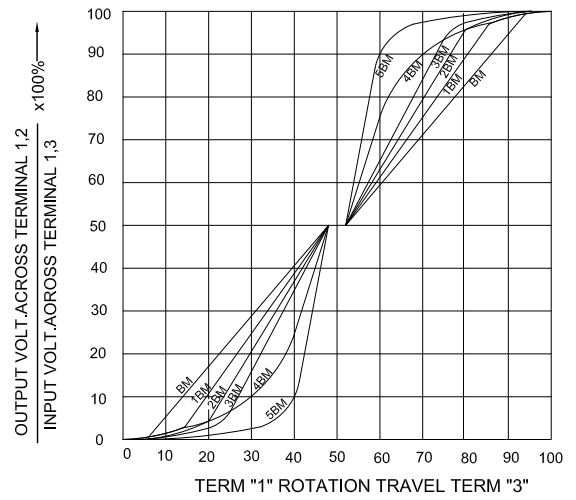

TAPER A SERIES

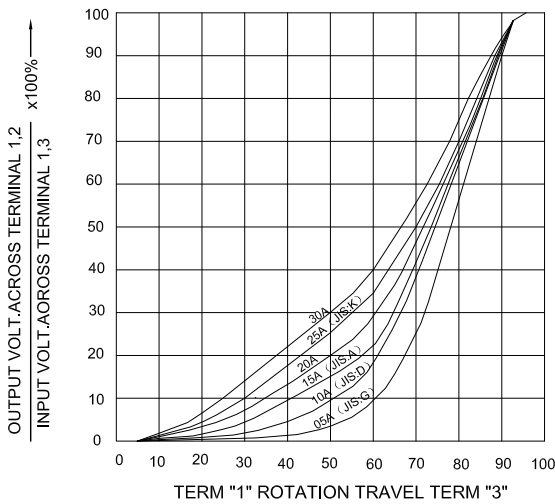

TAPER A & C WITH 50% TAP

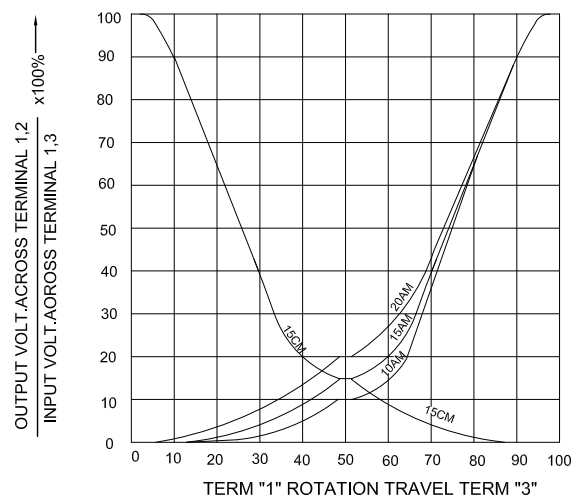

TAPER C SERIES

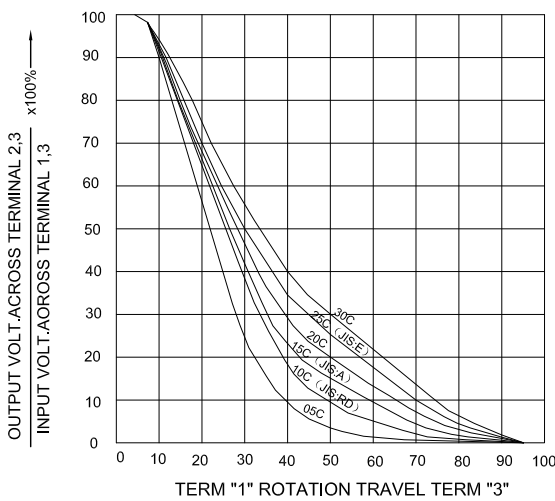

TAPER M & N SERIES

