

# 外形图 Mechanical Dimensions

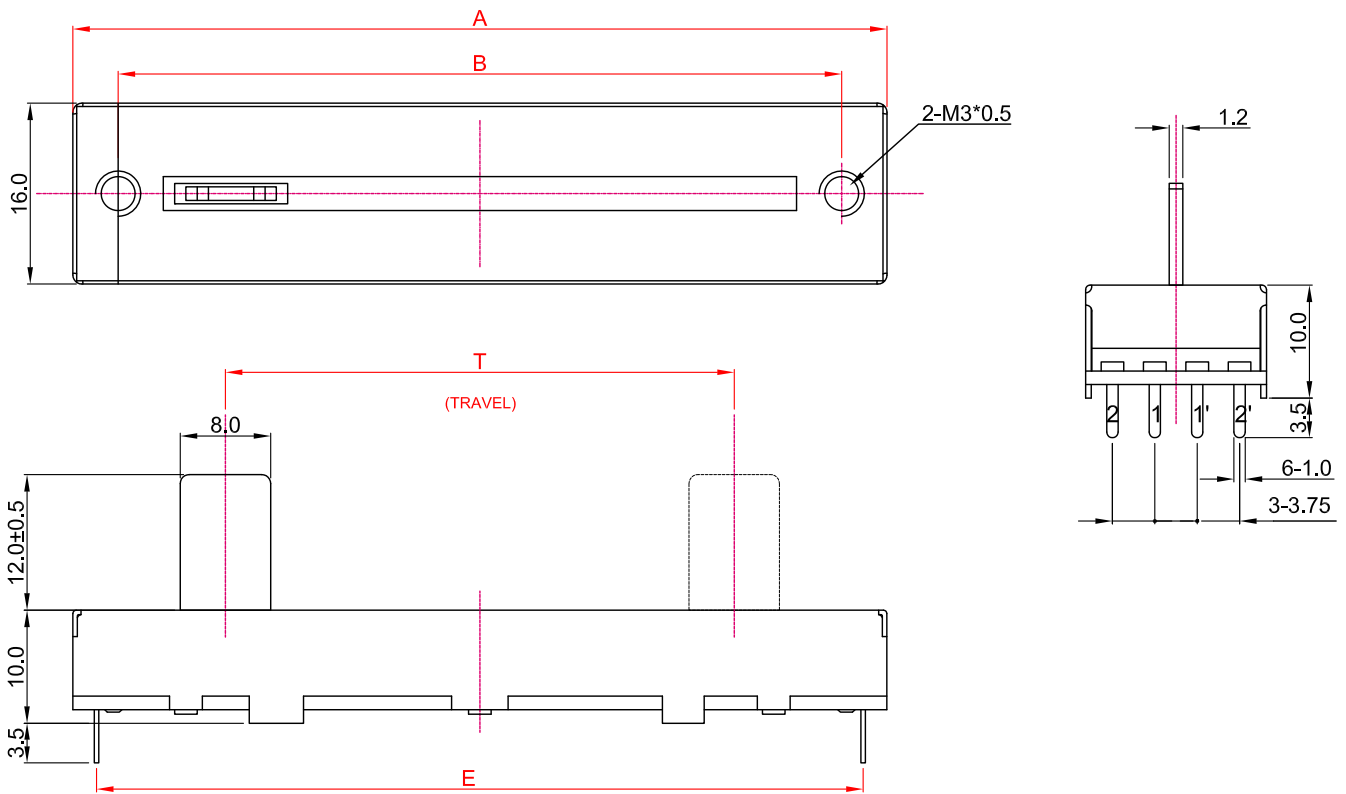

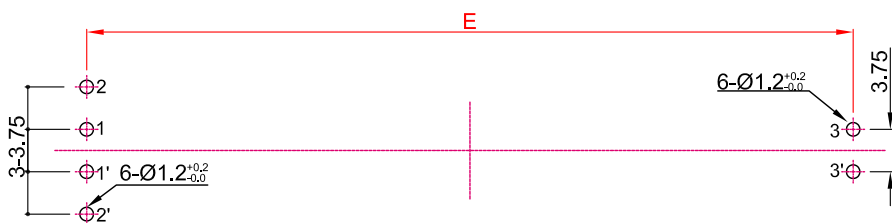

安装孔位图  
P.C.B. mounting hole detail



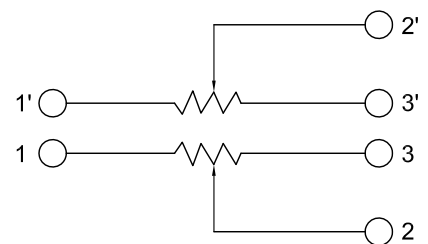

接线图  
Circuit explanation



	MODEL NO.	T	A	B	E
<input type="checkbox"/>	C4581G	45	72	65	67.8
<input checked="" type="checkbox"/>	C6081G	60	87	80	82.8
<input type="checkbox"/>	C0081G	100	127	120	122.8

3				PRODUCT NAME	Slide Potentiometer	
2				MODEL NAME	C <input type="checkbox"/> <input type="checkbox"/> 81G-12A1-value	
1						
NO	DATE	DESCRIPTION		APPROVED BY	CHECKED BY	DRAWN BY
		DIMENSION	TOLERANCE	SCALE		
		$\int \leq 10$	$\pm 0.2$	UNIT	mm	
		$10 < \int \leq 30$	$\pm 0.5$	VER.	AO	
		$30 < \int \leq 100$	$\pm 1.0$	DATE	2018/4/28	
		All Angles	$\pm 5^\circ$			
				 R & D 2018/4/28 Eva	 R & D 2018/4/28 Sophie	 R & D 2018/4/28 Dick

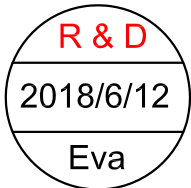
# 直滑式 Rotary Potentiometers series Specifications

1. 電氣性能 (Electrical Characteristics)								
1.1	全阻抗值 (Total Resistance)	1KΩ ~ 2MΩ						
1.2	全阻抗值允許偏差 (Total Resistance Tolerance)	±20% ( More than 1 M Ω ±30%)						
1.3	電阻隨溫度變化特性 Resistance of temperature change character	20°C-75°C:ΔR/R≤±5%, -25°C-20°C:ΔR/R≤±4.5%						
1.4	阻值變化特性 (Resistance Taper)	A, B, C, W						
1.5	零位阻值 (Residual Resistance)	R≥250KΩ / 0.1 % max. of total Value 250KΩ>R>10KΩ / 20Ω max. 10KΩ≥R / 10Ω max.						
1.6	額定功率 (Rated Power)	TAPER	TRAVEL					
			15mm	20mm	30mm	45mm	60mm	100mm
		Linear B:	0.025W	0.05W	0.1W	0.125W	0.125W	0.125W
		Other	0.012W	0.025W	0.05W	0.06W	0.06W	0.06W
1.7	最高使用電壓 (Max.Operating Voltage)	50V AC						
1.8	動雜音 (Rotational Noise)	Less Than 100mV						
1.9	絕緣阻抗 (Insulation Resistance)	More than 100MΩ at DC 250V						
1.10	耐電壓 (Withstand Voltage)	For 1 minute at: AC 300V						
1.11	开关額定功率(Switch Rated Power)	-----						
1.12	同步誤差 (Gang Error)	0dB~-40dB ≤3dB						
2. 機械性能 (Mechanical Characteristics)								
2.1	滑動行程 (Slide travel)	T=60±1.0mm						
2.2	滑動力矩 (Operating force)	10~200gf.cm						
2.3	柄的拉、押強度 (Pull-Push Strength)	Pull 3Kgf.cm / Push 5 Kgf.cm						
2.4	滑動止檔強度 (Rotational Stop-End Torque)	5 kgf.cm Min						
2.5	推柄擺動度 (Lever wobble)	2xL/25mm Max. (L=Lever length)						
2.6	旋轉定位數目 (Number of Detents(click))	detent: 0						
2.7	焊錫耐熱性 (Resistance To Soldering Heat)	260±5°C and less than 3 seconds						
3. 耐久性能 (Durability)								
3.1	回轉壽命 (Rotation Life)	10,000 Cycles min.						
3.2	工作溫度 (Operating temperature)	-10°C ~ +70°C						
4.1	外形尺寸圖/曲線特性圖 (Shape size drawing/curve characteristic drawing)	見附頁 Please refer the drawing						
批 准	審 核	設 計						
								

# RESISTANCE TAPER



### TAPER B SERIES

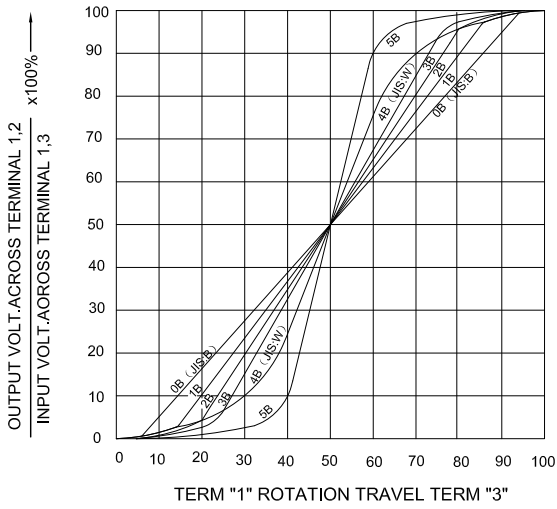

### TAPER B WITH 50% TAP

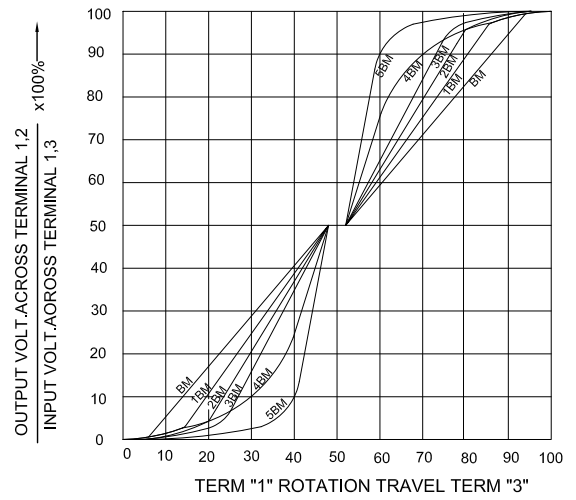

### TAPER A SERIES

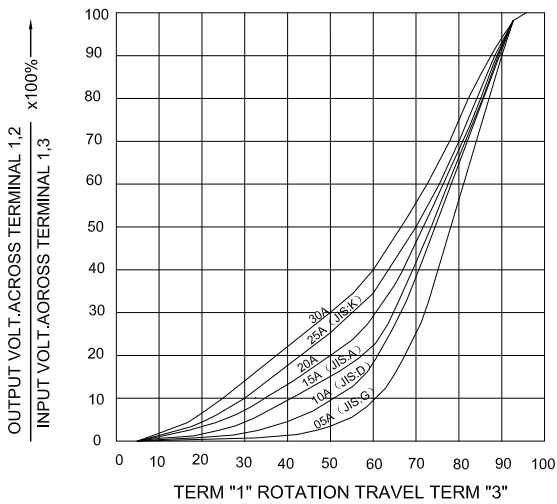

### TAPER A & C WITH 50% TAP

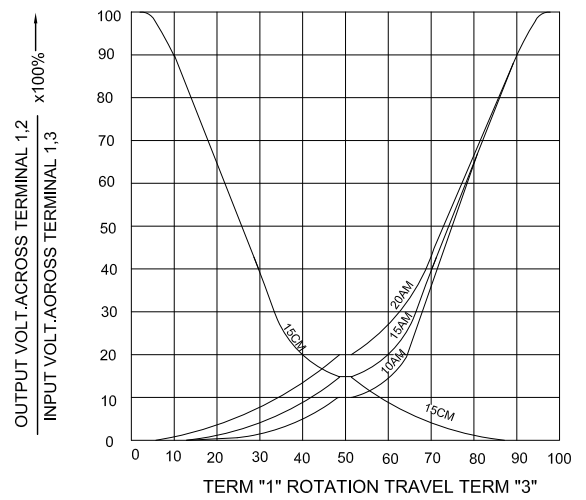

### TAPER C SERIES

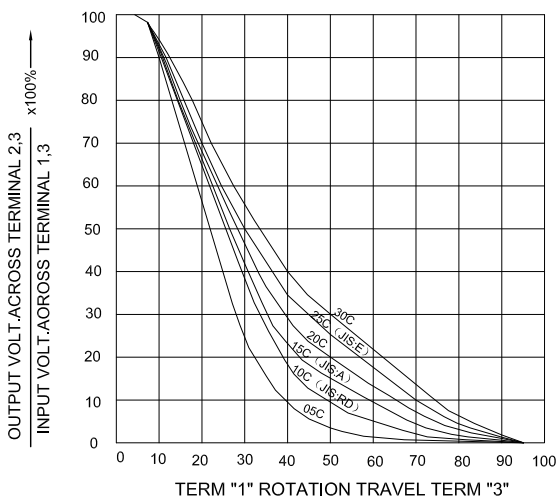

### TAPER M & N SERIES

