

外形图 Mechanical Dimensions

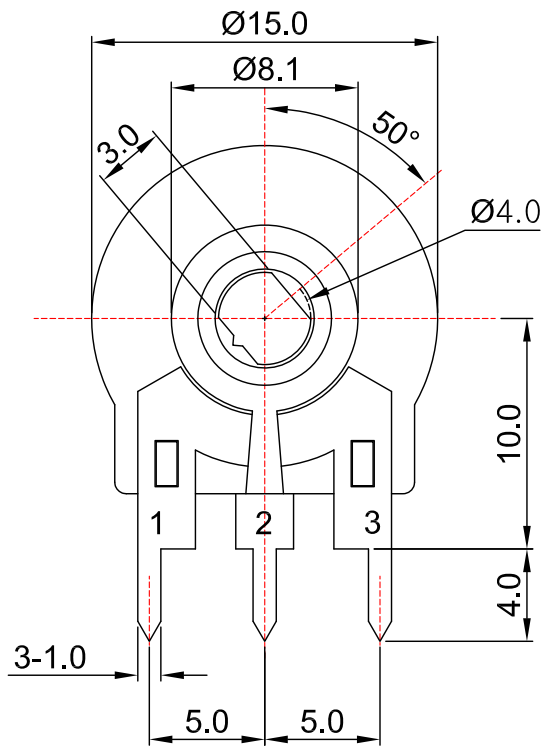

Shaft shown in full
C.C.W. position

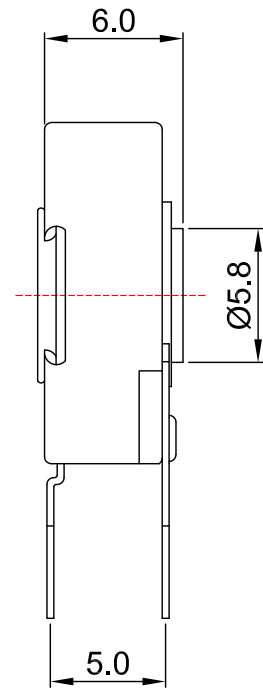

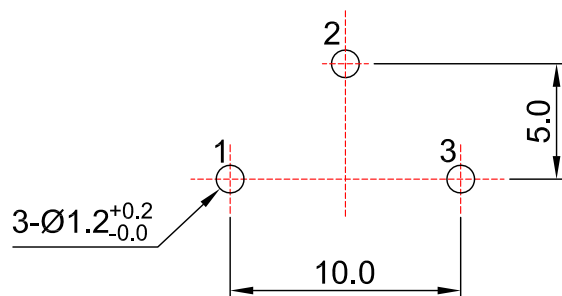
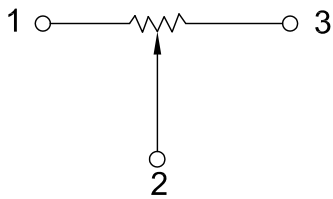

安装孔位置图
P.C.B. mounting hole detail

接线图
Circuit explanation



3				PRODUCT NAME	Rotary Potentiometer				
2				MODEL NAME	SB153-2-value				
1	NO	DATE	DESCRIPTION	APPROVED BY	CHECKED BY	DRAWN BY			
				<div style="border: 1px solid black; border-radius: 50%; padding: 5px; width: 60px; margin: 0 auto;"> R & D 2014/8/27 EVA </div>	<div style="border: 1px solid black; border-radius: 50%; padding: 5px; width: 60px; margin: 0 auto;"> R & D 2014/8/27 Sophie </div>	<div style="border: 1px solid black; border-radius: 50%; padding: 5px; width: 60px; margin: 0 auto;"> R & D 2014/8/27 Ball </div>			
		DIMENSION	TOLERANCE				SCALE	UNIT	mm
			$\int \leq 10$				± 0.2		mm
			$10 < \int \leq 30$				± 0.5	VER.	A0
			$30 < \int \leq 100$	± 1.0	DATE	2014/8/27			
			All Angles	$\pm 5^\circ$					

Semi-fix Potentiometers Series Specifications

1. 電氣性能 (Electrical Characteristics)					
1.1	全阻抗值 (Total Resistance)		500Ω ~ 2MΩ		
1.2	全阻抗值允許偏差 (Total Resistance Tolerance)		±20% (More than 1 M Ω ±30%)		
1.3	電阻隨溫度變化特性 Resistance of temperature change character)		20°C-75°C:ΔR/R≤±5%, -25°C-20°C:ΔR/R≤±4.5%		
1.4	阻值變化特性 (Resistance Taper)		A, B, C		
1.5	零位阻值 (Residual Resistance)		R≥250KΩ / 0.1 % max. of total Value 250KΩ>R>10KΩ / 20Ω max. 10KΩ≥R / 10Ω max.		
1.6	額定功率 (Rated Power)		Linear Taper B: 0.15W Other Taper:0.07W		
1.7	最高使用電壓 (Max.Operating Voltage)		150V AC ; 50V DC		
1.10	耐電壓 (Withstand Voltage)		For 1 minute at: AC 500V		
1.8	耐溫特性 (Temperature Characteristic)		-10°C~70°C:ΔR/R≤±8%		
1.9	潮濕環境下負載性能 (Load Life In Humidity)		20%Max 350 hours rated in 90%RH 40°C		
2. 機械性能 (Mechanical Characteristics)					
2.1	全回轉角度 (Rotation Angle)		260°±5°		
2.2	旋轉力矩 (Rotation Torque)		20~200gf.cm		
2.4	轉動止檔強度 (Rotational Stop-End Torque)		1.0 kgf.cm Max.		
2.8	焊錫耐熱性 (Resistance To Soldering Heat)		260±5°C and less than 3 seconds		
3. 耐久性能 (Durability)					
3.1	回轉壽命 (Rotation Life)		5000 Cycles min.		
3.2	工作溫度 (Operating temperature)		-10°C~+70°C		
4.1	外形尺寸圖/曲線特性圖 (Shape size drawing/curve characteristic drawing)		見附頁 Please refer the drawing		
批 准		審 核		設 計	

RESISTANCE TAPER



TAPER B SERIES

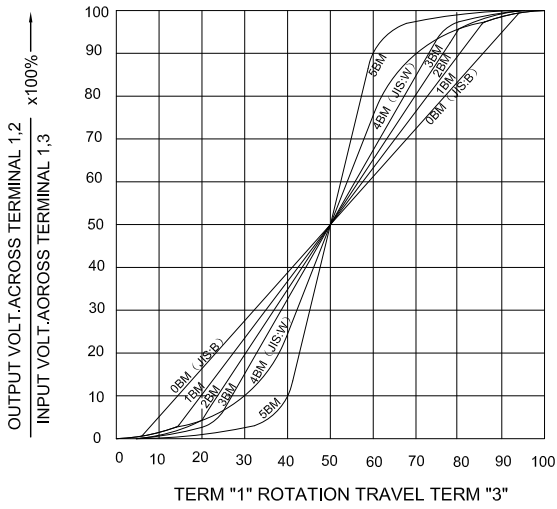

TAPER B WITH 50% TAP

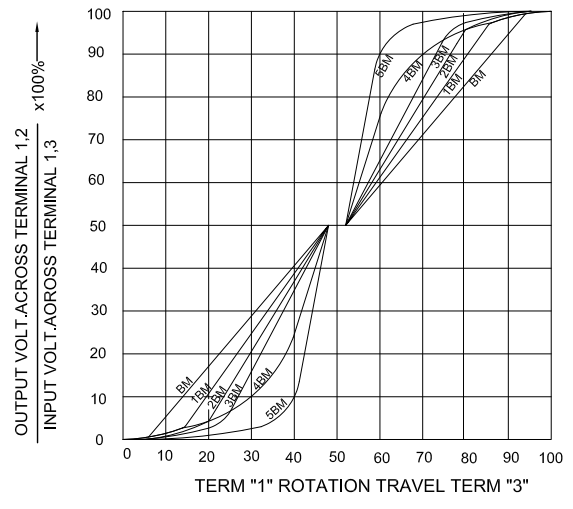

TAPER A SERIES

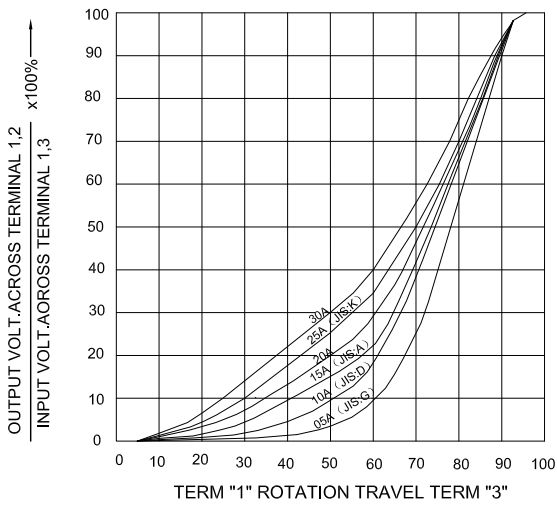

TAPER A & C WITH 50% TAP

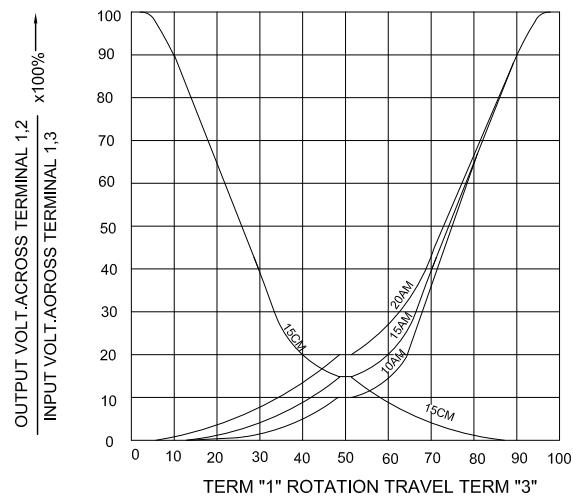

TAPER C SERIES

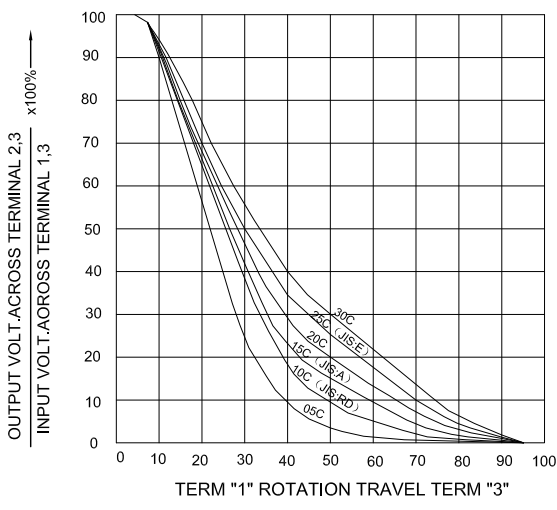

TAPER M & N SERIES

