

外形图

Mechanical Dimensions

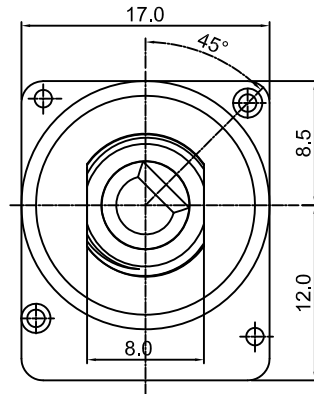
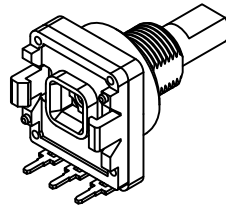
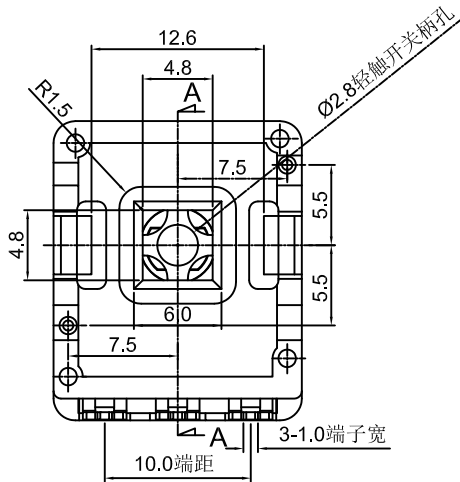
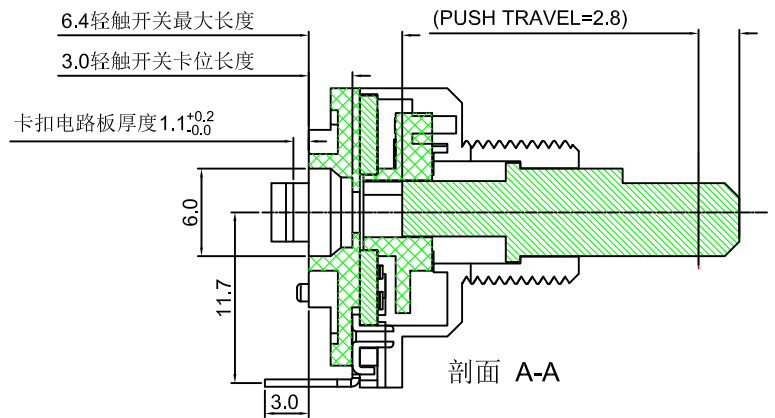
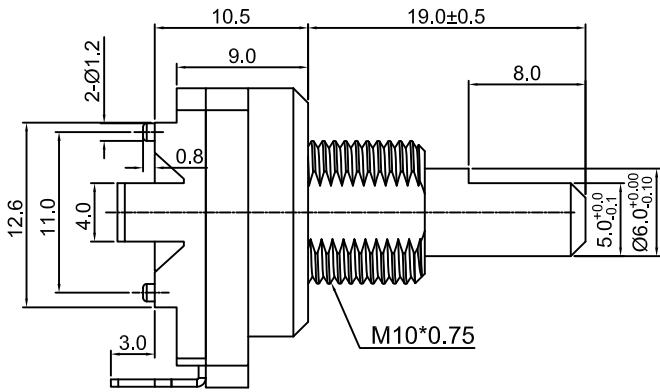

Shaft shown in full C.C.W. position

接线图
Circuit Explanation

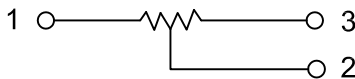

安装孔位置图
P.C.B. mounting hole detail

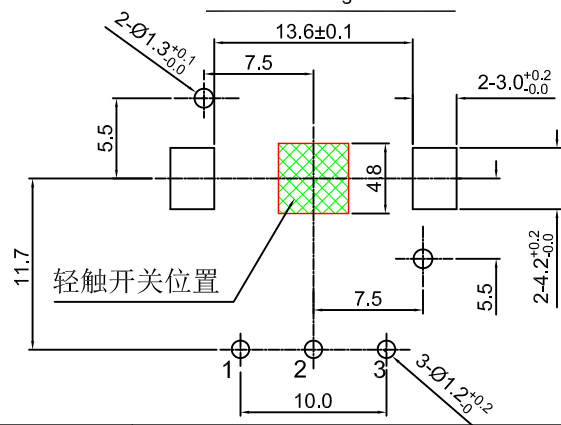

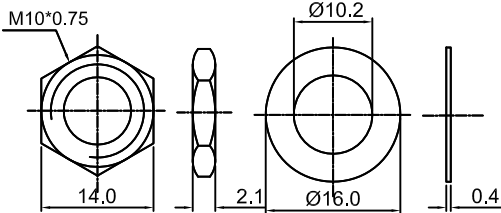

attached parts: nut & washer



				PRODUCT NAME	Rotary Potentiometer			
				MODEL NAME	R16PTS-2D1-value			
NO	DATE	DESCRIPTION		APPROVED BY	CHECKED BY	DRAWN BY		
DIMENSION		TOLERANCE	SCALE					
$\int \leq 10$		± 0.2	UNIT					mm
$10 < \int \leq 30$		± 0.5	VER.					A0
$30 < \int \leq 100$		± 1.0	DATE					2013/05/31
All Angles		$\pm 5^\circ$						

16 mm Push-on Potentiometers with SW series Specifications

1.電氣性能 (Electrical Characteristics)					
1.1	全阻抗值 (Total Resistance)	1KΩ ~ 2MΩ			
1.2	全阻抗值允許偏差 (Total Resistance Tolerance)	±20% (More than 1 M Ω ±30%)			
1.3	電阻隨溫度變化特性 (Resistance of temperature change character)	20°C-75°C:ΔR/R≤±5%, -25°C-20°C:ΔR/R≤±4.5%			
1.4	阻值變化特性 (Resistance Taper)	A, B			
1.5	零位阻值 (Residual Resistance)	R≥250KΩ / 0.1 % max. of total Value 250KΩ>R>10KΩ / 20Ω max. 10KΩ≥R / 10Ω max.			
1.6	額定功率 (Rated Power)	Linear Taper B: 0.5W Other Taper:0.2W			
1.7	最高使用電壓 (Max.Operating Voltage)	250VAC			
1.8	動雜音 (Rotational Noise)	Less Than 100mV			
1.9	絕緣阻抗 (Insulation Resistance)	More than 100MΩ at DC 250V			
1.10	耐電壓 (Withstand Voltage)	For 1 minute at: DC 500V			
1.11	开关額定功率(Switch Rated Power)	-----			
2.機械性能(Mechanical Characteristics)					
2.1	全回轉角度 (Rotation Angle)	270°±5°			
2.2	旋轉力矩 (Rotation Torque)	10~100gf.cm			
2.3	軸的拉、押強度 (Pull-Push Strength)	5 Kgf.cm			
2.4	轉動止檔強度 (Rotational Stop-End Torque)	3.5 kgf.cm Min			
2.5	开关行程(Switch Working Travel)	3.0±0.5mm			
2.6	开关力矩(Switch Working Torque)	50~150gf.cm			
2.7	旋轉定位數目 (Number of Detents(click))	0 detents / 16 detents /30 detents			
2.8	焊錫耐熱性 (Resistance To Soldering Heat)	260±5°C and less than 3 seconds			
3.耐久性能 (Durability)					
3.1	回轉壽命 (Rotation Life)	10,000 Cycles min.			
3.2	工作溫度 (Operating temperature)	-10°C~+70°C			
4.1	外形尺寸圖/曲線特性圖 (Shape size drawing/curve characteristic drawing)	見附頁 Please refer the drawing			
批 准		審 核		設 計	

RESISTANCE TAPER



TAPER B SERIES

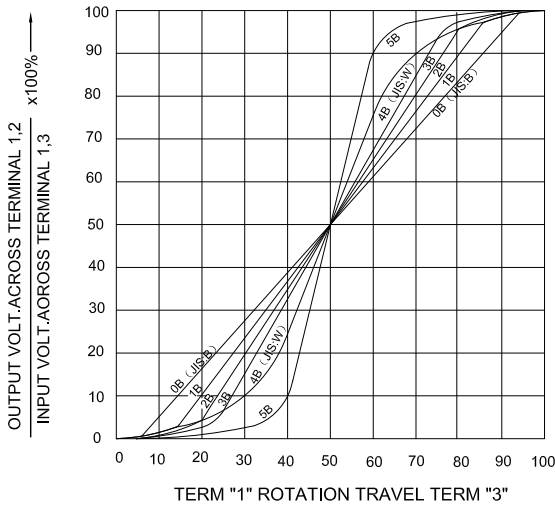

TAPER B WITH 50% TAP

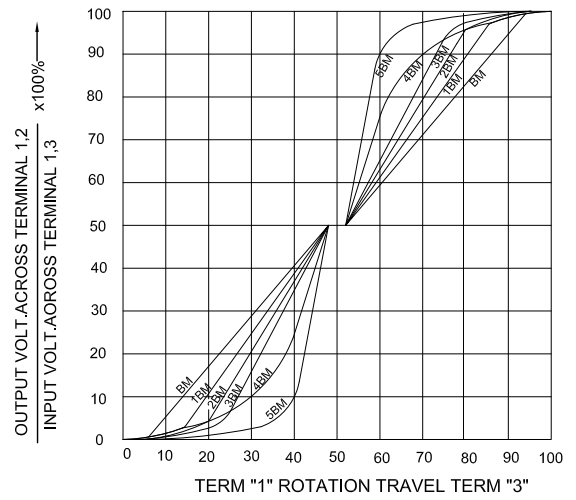

TAPER A SERIES

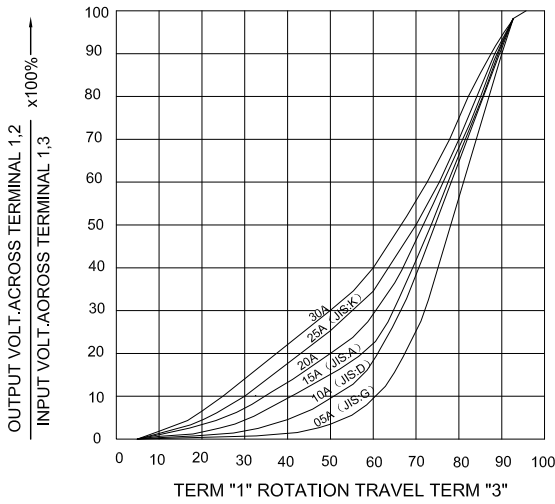

TAPER A & C WITH 50% TAP

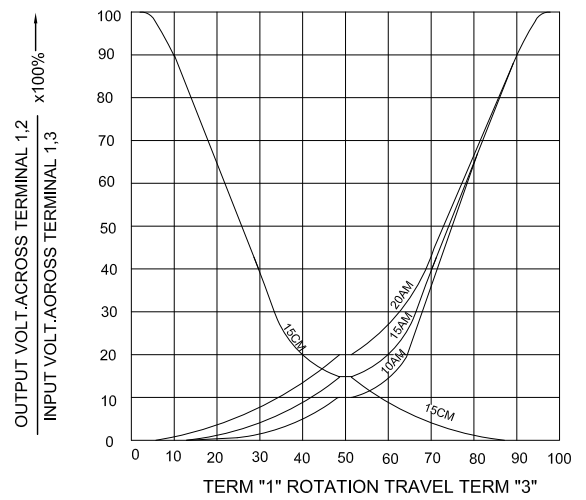

TAPER C SERIES

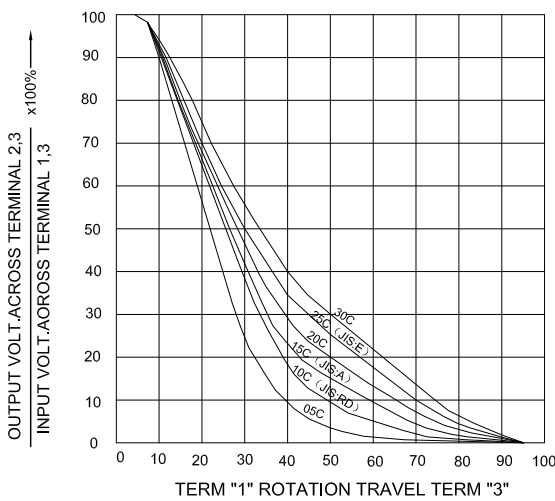

TAPER M & N SERIES

