

外形图 Mechanical Dimensions

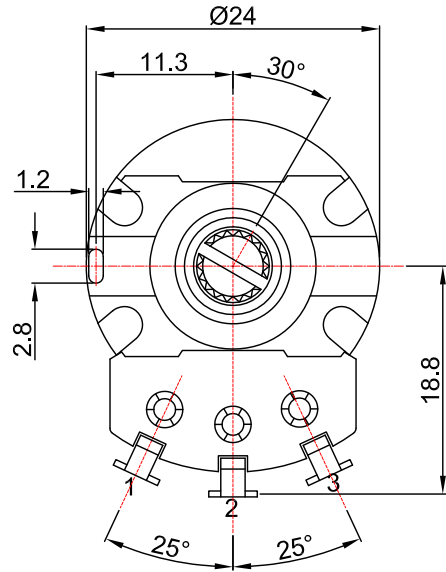

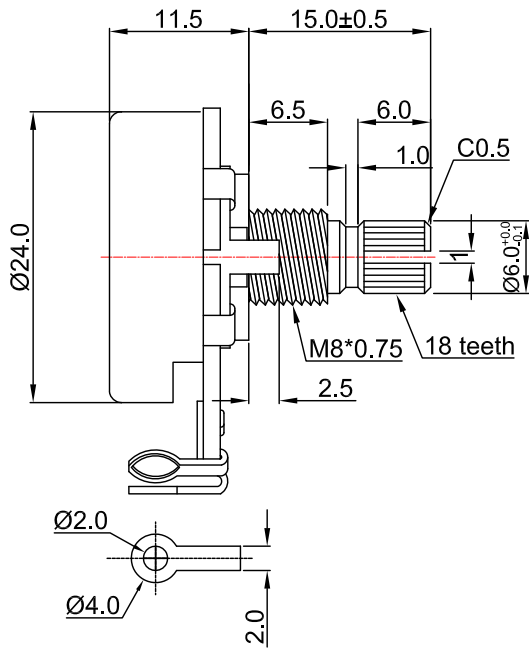
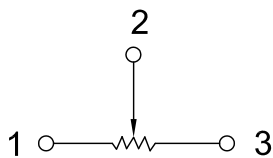

Shaft shown in full C.C.W. position

接线图
Circuit explanation



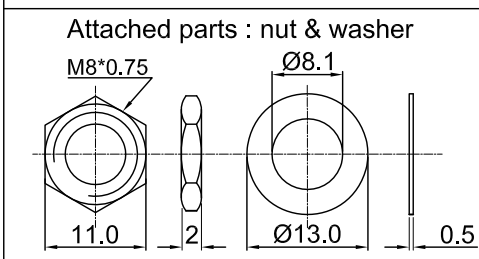
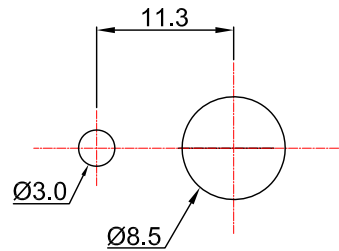

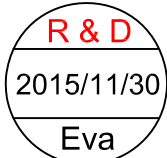
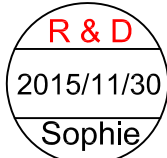
安装孔位图
P.C.B. mounting hole detail



3					PRODUCT NAME	Rotary Potentiometer	
2					MODEL NAME	R2410N-2B1-Value	
1							
NO	DATE	DESCRIPTION			APPROVED BY	CHECKED BY	DRAWN BY
		DIMENSION	TOLERANCE	SCALE			
		$l \leq 10$	± 0.2	UNIT			
		$10 < l \leq 30$	± 0.5	VER.			
		$30 < l \leq 100$	± 1.0	DATE	2015/11/30		
		All Angles	$\pm 5^\circ$				
							

24 mm Rotary Potentiometers Series Specifications

1. 電氣性能 (Electrical Characteristics)			
1.1	全阻抗值 (Total Resistance)	1K Ω ~ 2M Ω	
1.2	全阻抗值允許偏差 (Total Resistance Tolerance)	$\pm 20\%$ (More than 1 M Ω $\pm 30\%$)	
1.3	電阻隨溫度變化特性 Resistance of temperature change character)	20 $^{\circ}$ C-75 $^{\circ}$ C: $\Delta R/R \leq \pm 5\%$, -25 $^{\circ}$ C-20 $^{\circ}$ C: $\Delta R/R \leq \pm 4.5\%$	
1.4	阻值變化特性 (Resistance Taper)	A, B, C, W	
1.5	零位阻值 (Residual Resistance)	R \geq 250K Ω / 0.1 % max. of total Value 250K Ω >R>10K Ω / 20 Ω max. 10K Ω \geq R / 10 Ω max.	
1.6	額定功率 (Rated Power)	Linear Taper B: 0.5W Other Taper:0.25W	
1.7	最高使用電壓 (Max.Operating Voltage)	250V AC	
1.8	動雜音 (Rotational Noise)	Less Than 100mV	
1.9	絕緣阻抗 (Insulation Resistance)	More than 50M Ω at DC 500V	
1.10	耐電壓 (Withstand Voltage)	For 1 minute at: AC 500V	
1.11	开关額定功率(Switch Rated Power)	-----	
1.12	同步誤差 (Gang Error)	-----	
2. 機械性能 (Mechanical Characteristics)			
2.1	全回轉角度 (Rotation Angle)	300 $^{\circ}$ \pm 10 $^{\circ}$	
2.2	旋轉力矩 (Rotation Torque)	20~200gf.cm	
2.3	軸的拉、押強度 (Pull-Push Strength)	Pull 3Kgf.cm / Push 5 Kgf.cm	
2.4	轉動止檔強度 (Rotational Stop-End Torque)	5 kgf.cm Min	
2.5	开关角度(Switch Working Angel)	-----	
2.6	开关力矩(Switch Working Torque)	-----	
2.7	旋轉定位數目 (Number of Detents(click))	-----	
2.8	焊錫耐熱性 (Resistance To Soldering Heat)	260 \pm 5 $^{\circ}$ C and less than 3 seconds	
3. 耐久性能 (Durability)			
3.1	回轉壽命 (Rotation Life)	10,000 Cycles min.	
3.2	工作溫度 (Operating temperature)	-10 $^{\circ}$ C~+70 $^{\circ}$ C	
4.1	外形尺寸圖/曲線特性圖 (Shape size drawing/curve characteristic drawing)	見附頁 Please refer the drawing	
批准		審 核 	設 計 

RESISTANCE TAPER



TAPER B SERIES

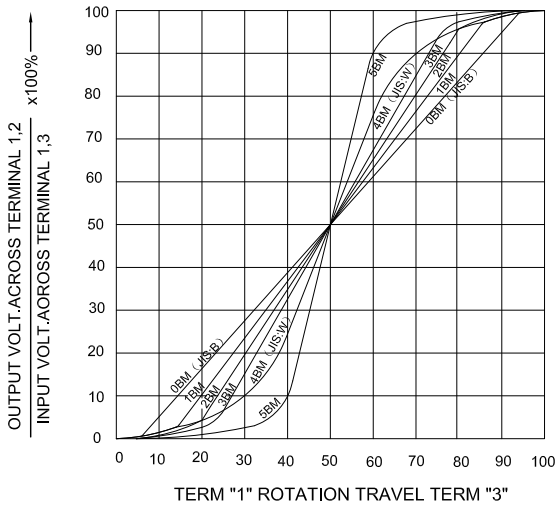

TAPER B WITH 50% TAP

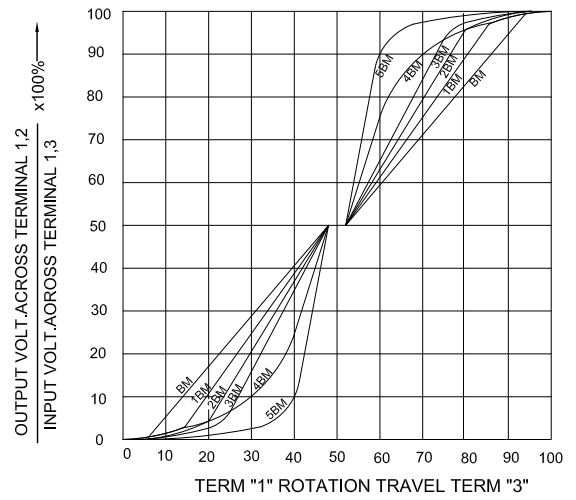

TAPER A SERIES

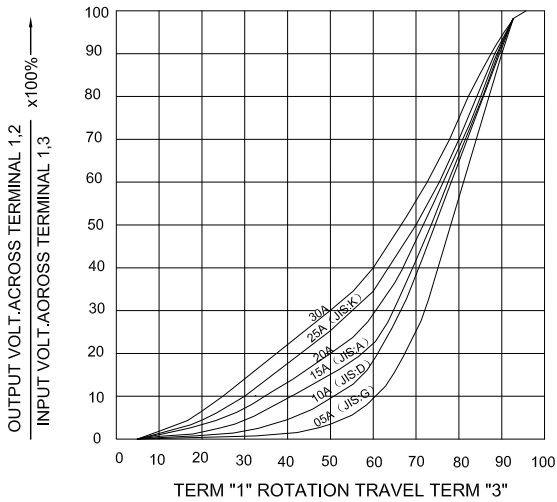

TAPER A & C WITH 50% TAP

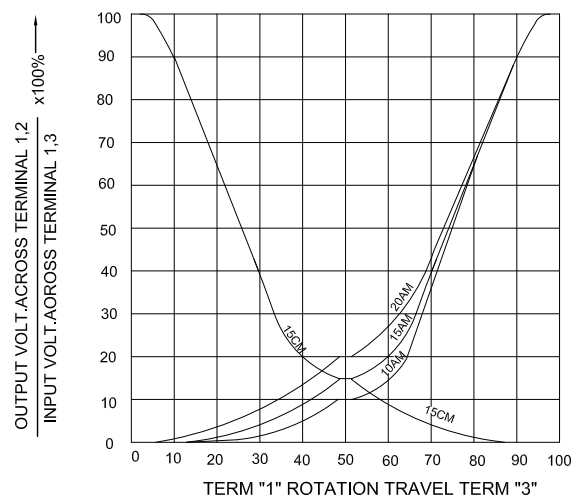

TAPER C SERIES

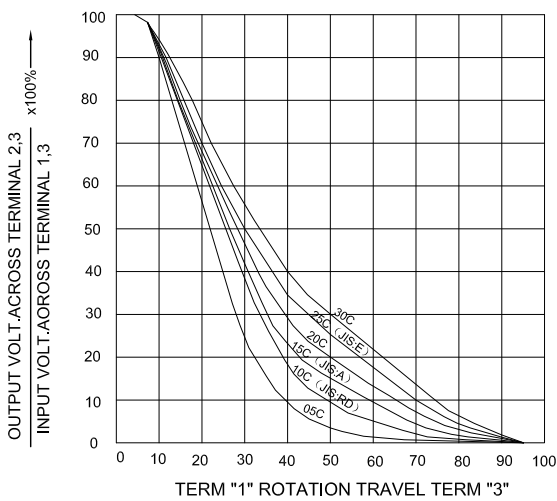

TAPER M & N SERIES

