

# 外形图 Mechanical Dimensions

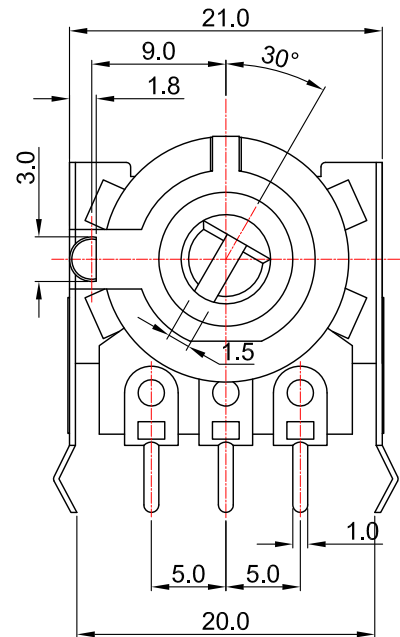

Shaft shown in full  
C.C.W. position

接线图  
Circuit explanation

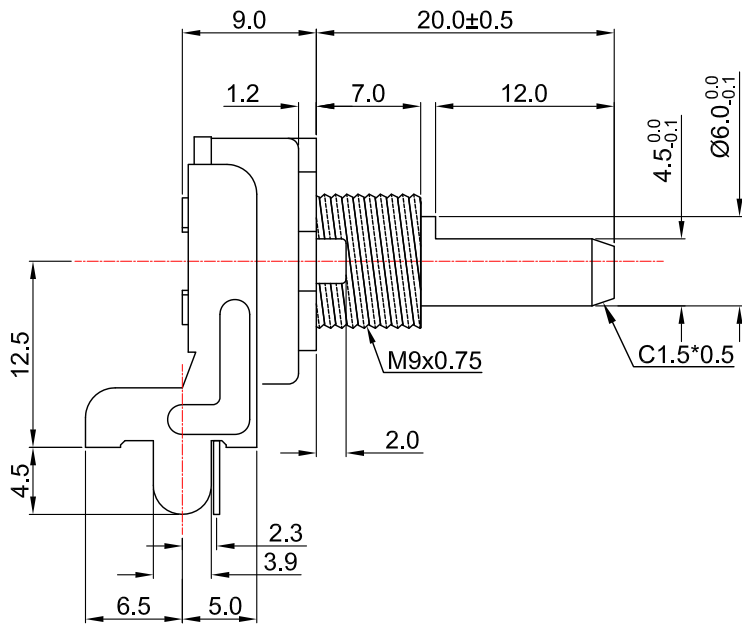
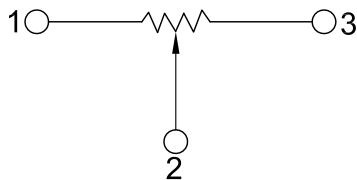

安装孔位图  
P.C.B. mounting hole detail

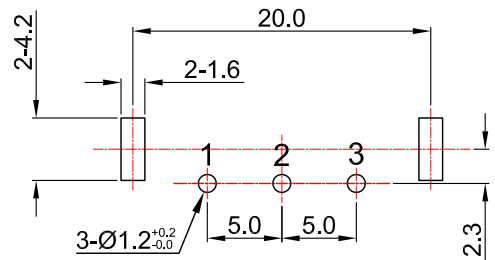

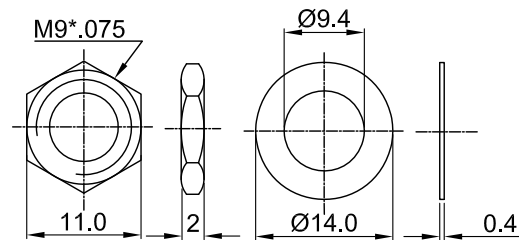

Attached parts : nut & washer



3					PRODUCT NAME	Rotary Potentiometer	
2					MODEL NAME	R1612N-1A1-Value-V01	
1					APPROVED BY	CHECKED BY	DRAWN BY
NO	DATE	DESCRIPTION					
DIMENSION	TOLERANCE	SCALE					
$\int \leq 10$	$\pm 0.2$	UNIT	mm				
$10 < \int \leq 30$	$\pm 0.5$	VER.	A0				
$30 < \int \leq 100$	$\pm 1.0$	DATE	2014/7/22				
All Angles	$\pm 5^\circ$						

# 16 mm Rotary Potentiometers series Specifications

1.電氣性能 (Electrical Characteristics)	
1.1	全阻抗值 (Total Resistance) <b>1KΩ ~ 2MΩ</b>
1.2	全阻抗值允許偏差 (Total Resistance Tolerance) ±20% ( More than 1 M Ω ±30%)
1.3	電阻隨溫度變化特性 Resistance of temperature change character) 20°C-75°C:ΔR/R≤±5%, -25°C-20°C:ΔR/R≤±4.5%
1.4	阻值變化特性 (Resistance Taper) <b>A, B, C, W</b>
1.5	零位阻值 (Residual Resistance) R≥250KΩ / 0.1 % max. of total Value 250KΩ>R>10KΩ / 20Ω max. 10KΩ≥R / 10Ω max.
1.6	額定功率 (Rated Power) Linear Taper B: 0.1W Other Taper:0.05W
1.7	最高使用電壓 (Max.Operating Voltage) 100V AC ; 50V DC
1.8	動雜音 (Rotational Noise) Less Than 100mV
1.9	絕緣阻抗 (Insulation Resistance) More than 100MΩ at DC 500V
1.10	耐電壓 (Withstand Voltage) For 1 minute at: AC 500V
1.11	开关額定功率(Switch Rated Power) -----
1.12	同步誤差 (Gang Error) -----
2.機械性能 (Mechanical Characteristics)	
2.1	全回轉角度 (Rotation Angle) 300°±10°
2.2	旋轉力矩 (Rotation Torque) 20~150gf.cm
2.3	軸的拉、押強度 (Pull-Push Strength) Pull 3Kgf.cm / Push 5 Kgf.cm
2.4	轉動止檔強度 (Rotational Stop-End Torque) 3 kgf.cm Min
2.5	开关角度(Switch Working Angel) -----
2.6	开关力矩(Switch Working Torque) -----
2.7	旋轉定位數目 (Number of Detents(click) -----
2.8	焊錫耐熱性 (Resistance To Soldering Heat) <u>260±5</u> °C and less than <u>3</u> seconds
3.耐久性能 (Durability)	
3.1	回轉壽命 (Rotation Life) 10,000 Cycles min.
3.2	工作溫度 (Operating temperature) -10°C~+70°C
4.1	外形尺寸圖/曲線特性圖 (Shape size drawing/curve characteristic drawing) 見附頁 Please refer the drawing
批准	 審 核  設 計 

# RESISTANCE TAPER



### TAPER B SERIES

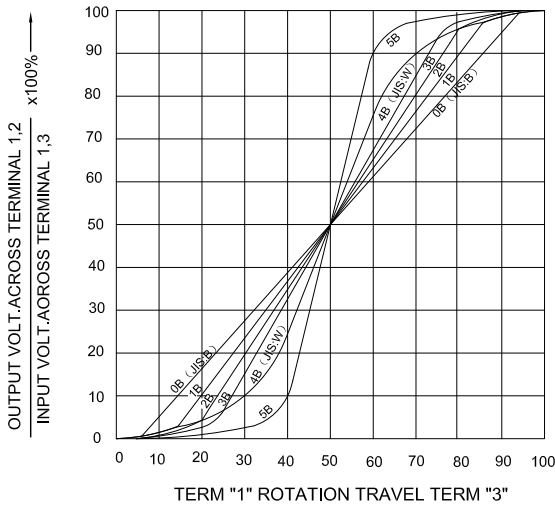

### TAPER B WITH 50% TAP

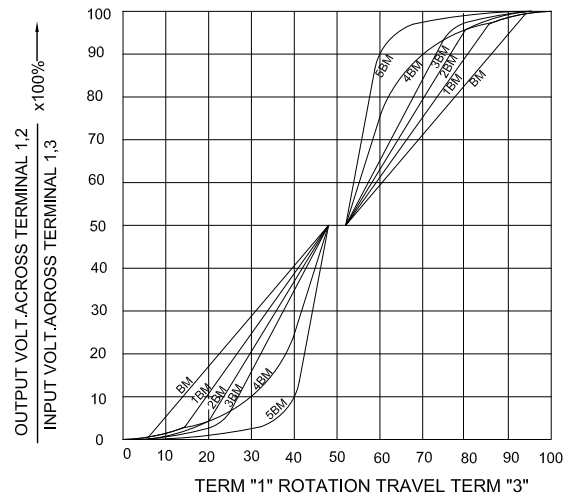

### TAPER A SERIES

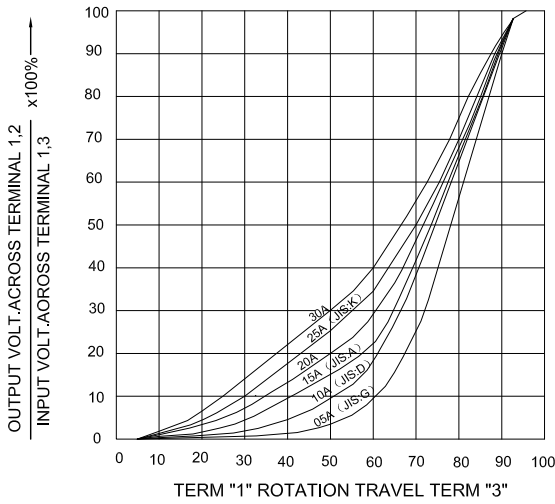

### TAPER A & C WITH 50% TAP

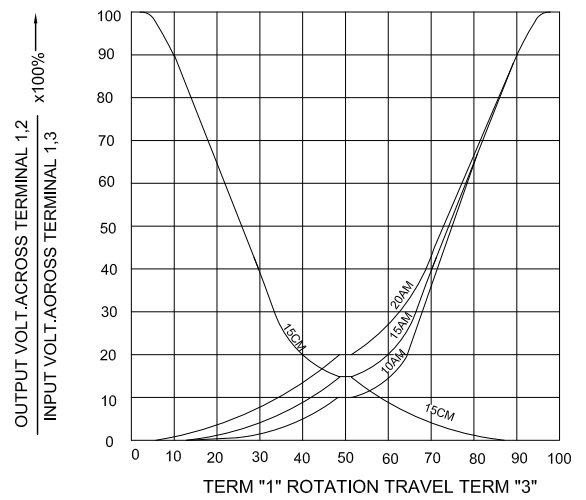

### TAPER C SERIES

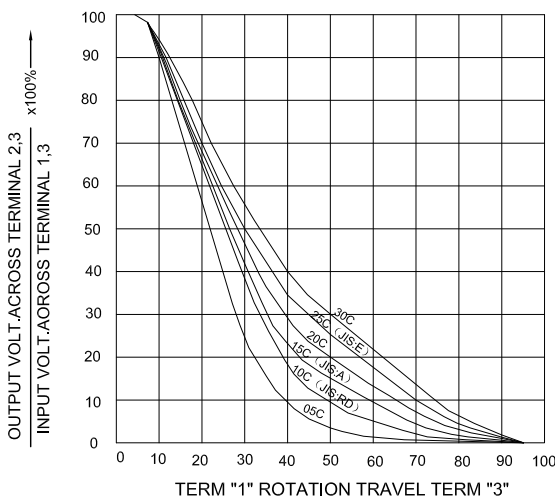

### TAPER M & N SERIES

