

外形图 Mechanical Dimensions

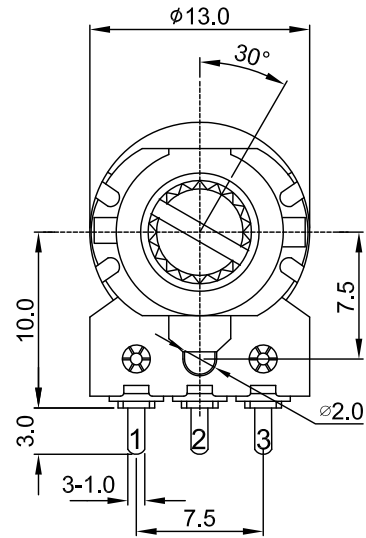

Shaft shown in full C.C.W. position

接线图
Circuit explanation

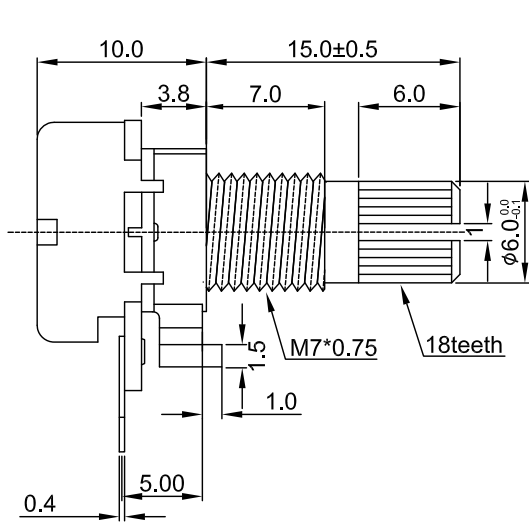
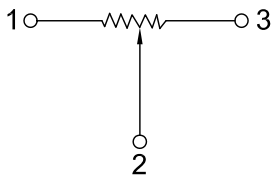

安装孔位置图
P.C.B. mounting hole detail

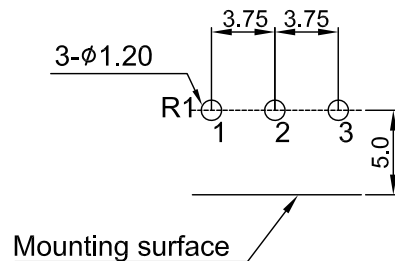

Attached parts : nut & washer

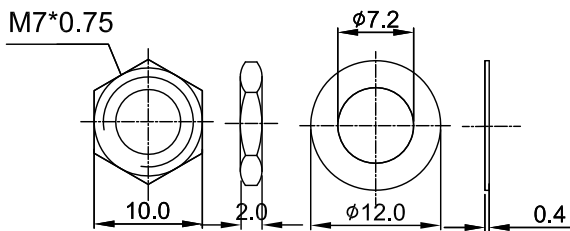

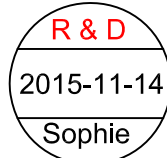
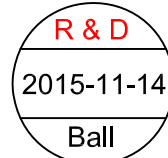
3				PRODUCT NAME	Rotary Potentiometer	
2				MODEL NAME	RD1210N-2A1-value	
1				APPROVED BY	CHECKED BY	DRAWN BY
NO	DATE	DESCRIPTION				
	DIMENSION	TOLERANCE	SCALE			
	$l \leq 10$	± 0.2	UNIT			
	$10 < l \leq 30$	± 0.5	VER.			
	$30 < l \leq 100$	± 1.0	DATE			
	All Angles	$\pm 5^\circ$				
						

12 mm Rotary Potentiometers series Specifications

1.電氣性能 (Electrical Characteristics)					
1.1	全阻抗值 (Total Resistance)		1K Ω ~ 2M Ω		
1.2	全阻抗值允许偏差 (Total Resistance Tolerance)		$\pm 20\%$ (More than 1 M Ω $\pm 30\%$)		
1.3	電阻隨溫度變化特性 Resistance of temperature change character)		20 $^{\circ}$ C -75 $^{\circ}$ C : $\Delta R/R \leq \pm 5\%$, -25 $^{\circ}$ C -20 $^{\circ}$ C : $\Delta R/R \leq \pm 4.5\%$		
1.4	阻值變化特性 (Resistance Taper)		A, B , C, W		
1.5	零位阻值 (Residual Resistance)		R \geq 250K Ω / 0.1 % max. of total Value 250K Ω >R>10K Ω / 20 Ω max. 10K Ω >R / 10 Ω max.		
1.6	額定功率 (Rated Power)		Linear Taper B: 0.05W Other Taper:0.025W		
1.7	最高使用電壓 (Max.Operating Voltage)		100V AC		
1.8	動雜音 (Rotational Noise)		Less Than 100mV		
1.9	絕緣阻抗 (Insulation Resistance)		More than 100M Ω at DC 250V		
1.10	耐電壓 (Withstand Voltage)		For 1 minute at: AC 300V		
1.11	开关額定功率(Switch Rated Power)		-----		
1.12	同步誤差 (Gang Error)		-----		
2.機械性能 (Mechanical Characteristics)					
2.1	全回轉角度 (Rotation Angle)		300 $^{\circ}$ \pm 10 $^{\circ}$		
2.2	旋轉力矩 (Rotation Torque)		20~200gf.cm		
2.3	軸的拉、押強度 (Pull-Push Strength)		5 Kgf.cm		
2.4	轉動止檔強度 (Rotational Stop-End Torque)		3 kgf.cm Min		
2.5	开关角度(Switch Working Angel)		-----		
2.6	开关力矩(Switch Working Torque)		-----		
2.7	旋轉定位數目 (Number of Detents(click))		detent: 0 ; 1;		
2.8	焊錫耐熱性 (Resistance To Soldering Heat)		<u>260\pm5$^{\circ}$C</u> and less than <u>3</u> seconds		
3.耐久性能 (Durability)					
3.1	回轉壽命 (Rotation Life)		10,000 Cycles min.		
3.2	工作溫度 (Operating temperature)		-10 $^{\circ}$ C ~+70 $^{\circ}$ C		
4.1	外形尺寸圖/曲線特性圖 (Shape size drawing/curve characteristic drawing)		見附頁 Please refer the drawing		
批 准		審 核		設 計	

RESISTANCE TAPER

TAPER B SERIES

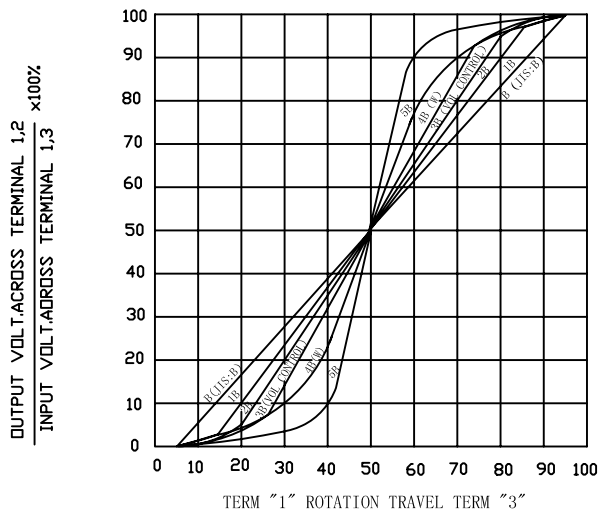

TAPER B WITH 50% TAP

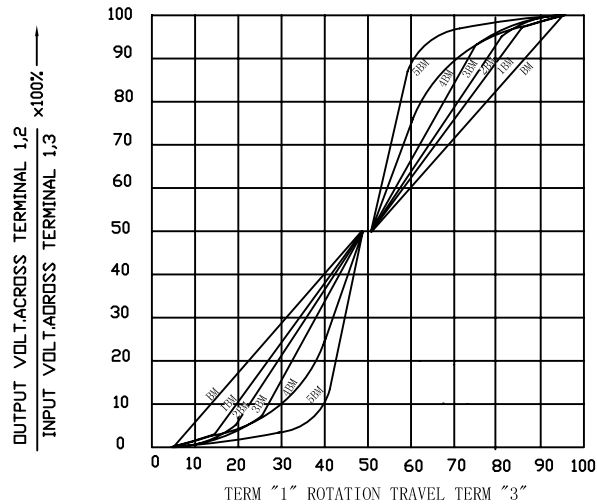

TAPER A SERIES

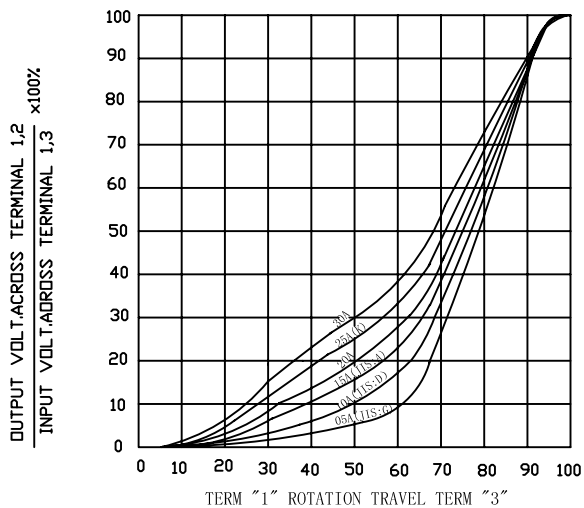

TAPER A & C WITH 50% TAP

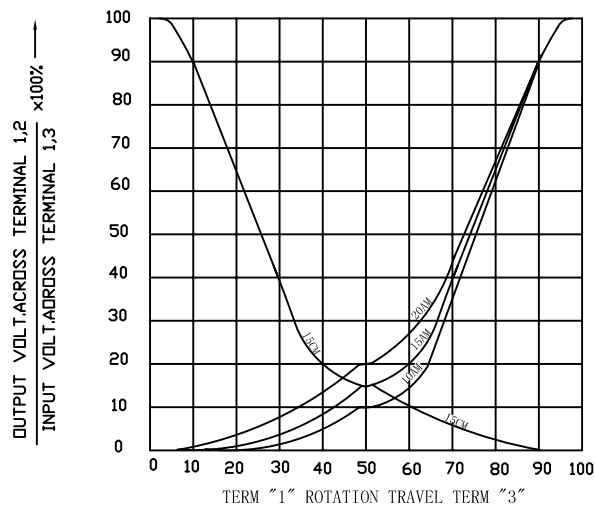

TAPER C SERIES

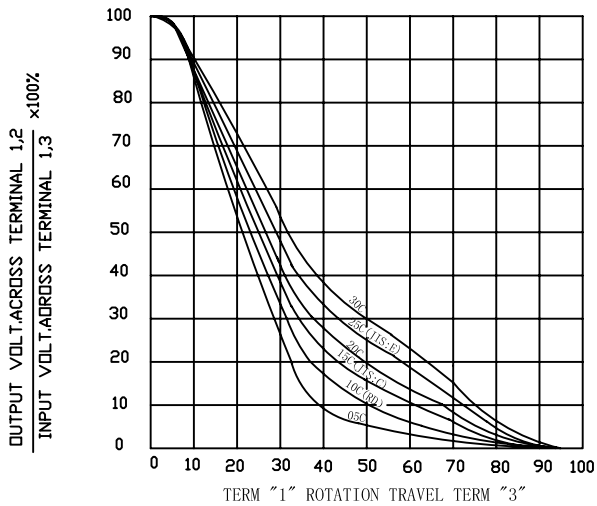

TAPER M & N SERIES

