

外形图 Mechanical Dimensions

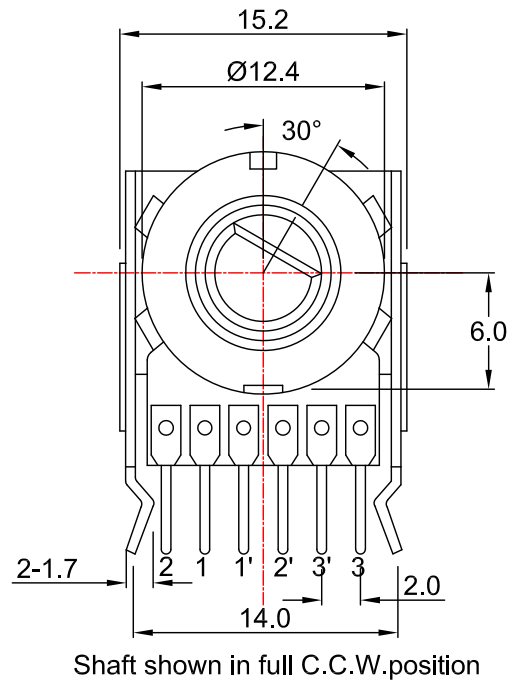

安装孔位图
P.C.B. mounting hole detail

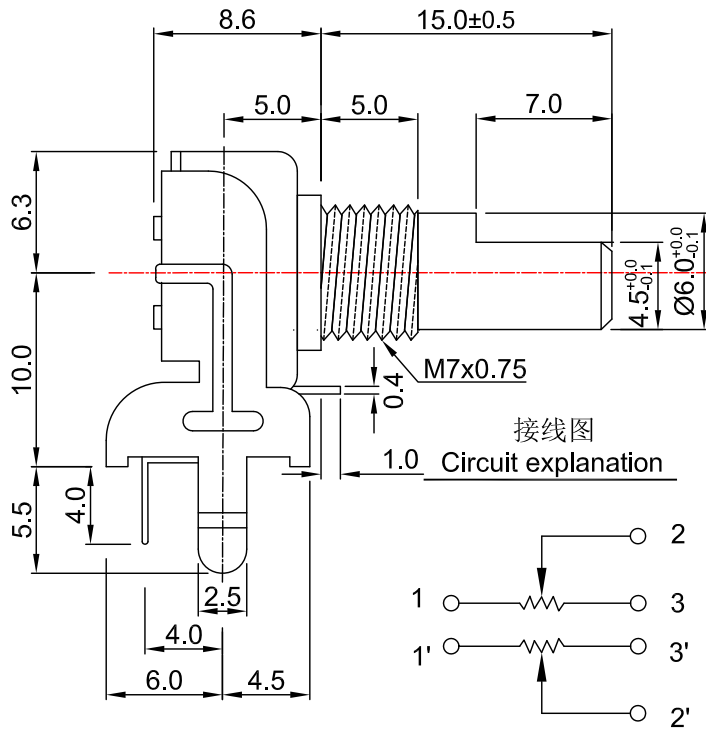

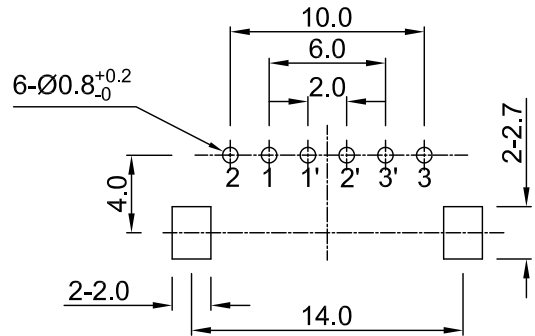

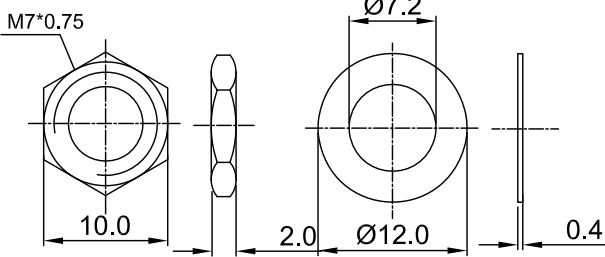





Attached parts: nut & washer



3				PRODUCT NAME	Rotary Potentiometer	
2				MODEL NAME	RD1212G-AA2-value	
1				APPROVED BY	CHECKED BY	DRAWN BY
NO	DATE	DESCRIPTION				
DIMENSION	TOLERANCE	SCALE				
$\int \leq 10$	± 0.2	UNIT	mm			
$10 < \int \leq 30$	± 0.5	VER.	A0			
$30 < \int \leq 100$	± 1.0	DATE	2014/9/10			
All Angles	$\pm 5^\circ$					

12 mm Rotary Potentiometers series Specifications

1.電氣性能 (Electrical Characteristics)						
1.1	全阻抗值 (Total Resistance) 1KΩ ~ 2MΩ					
1.2	全阻抗值允許偏差 (Total Resistance Tolerance) ±20% (More than 1 M Ω ±30%)					
1.3	電阻隨溫度變化特性 Resistance of temperature change character) 20°C-75°C:ΔR/R≤±5%, -25°C-20°C:ΔR/R≤±4.5%					
1.4	阻值變化特性 (Resistance Taper) A, B , C, W					
1.5	零位阻值 (Residual Resistance) R≥250KΩ / 0.1 % max. of total Value 250KΩ>R>10KΩ / 20Ω max. 10KΩ≥R / 10Ω max.					
1.6	額定功率 (Rated Power) Linear Taper B: 0.05W Other Taper:0.025W					
1.7	最高使用電壓 (Max.Operating Voltage) 50V AC; 20V DC					
1.8	動雜音 (Rotational Noise) Less Than 100mV					
1.9	絕緣阻抗 (Insulation Resistance) More than 100MΩ at DC 250V					
1.10	耐電壓 (Withstand Voltage) For 1 minute at: AC 300V					
1.11	开关額定功率(Switch Rated Power) -----					
1.12	同步誤差 (Gang Error) .-40dB to 0dB 3dB max.					
2.機械性能 (Mechanical Characteristics)						
2.1	全回轉角度 (Rotation Angle) 300°±10°					
2.2	旋轉力矩 (Rotation Torque) 20~200gf.cm					
2.3	軸的拉、押強度 (Pull-Push Strength) Pull 3Kgf.cm / Push 5 Kgf.cm					
2.4	轉動止檔強度 (Rotational Stop-End Torque) 3 kgf.cm Min					
2.5	开关角度(Switch Working Angel) -----					
2.6	开关力矩(Switch Working Torque) -----					
2.7	旋轉定位數目 (Number of Detents(click) detent: 0 ; Or 1 center click					
2.8	焊錫耐熱性 (Resistance To Soldering Heat) 260±5°C and less than 3 seconds					
3.耐久性能 (Durability)						
3.1	回轉壽命 (Rotation Life) 10,000 Cycles min.					
3.2	工作溫度 (Operating temperature) -10°C ~ +70°C					
4.1	外形尺寸圖/曲線特性圖 (Shape size drawing/curve characteristic drawing) 見附頁 Please refer the drawing					
批准	<table border="0" style="width:100%; text-align:center;"> <tr> <td style="width:33%;"></td> <td style="width:10%; vertical-align:middle;">審核</td> <td style="width:33%;"></td> <td style="width:10%; vertical-align:middle;">設計</td> <td style="width:33%;"></td> </tr> </table>		審核		設計	
	審核		設計			

RESISTANCE TAPER



TAPER B SERIES

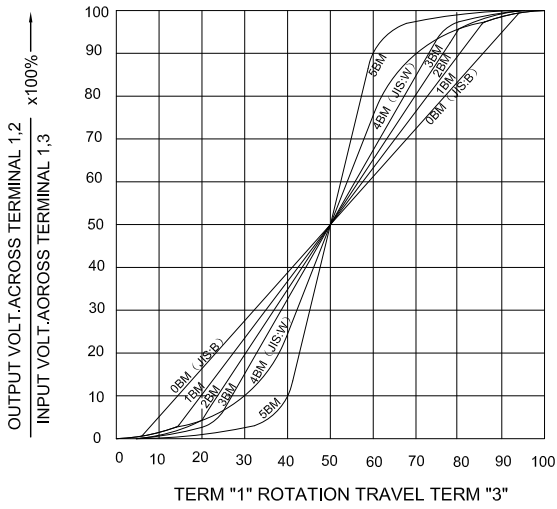

TAPER B WITH 50% TAP

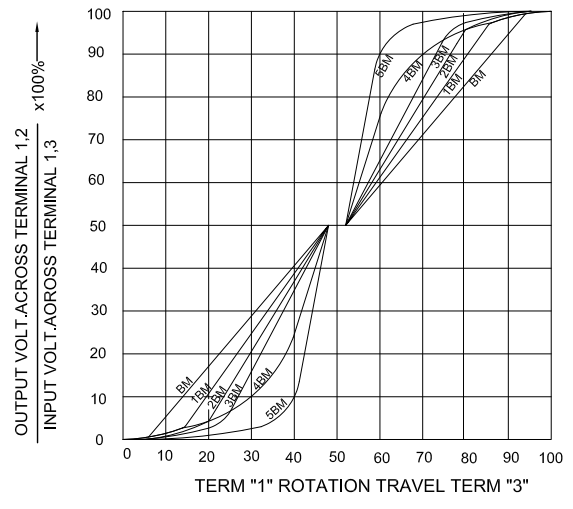

TAPER A SERIES

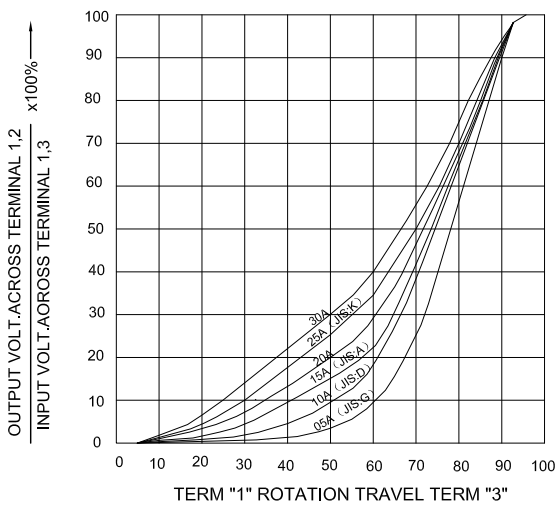

TAPER A & C WITH 50% TAP

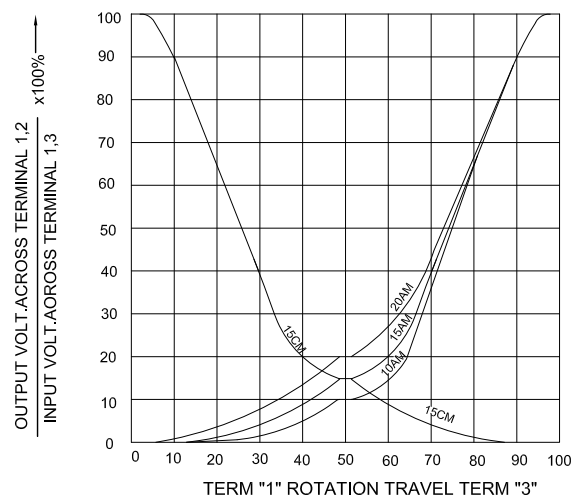

TAPER C SERIES

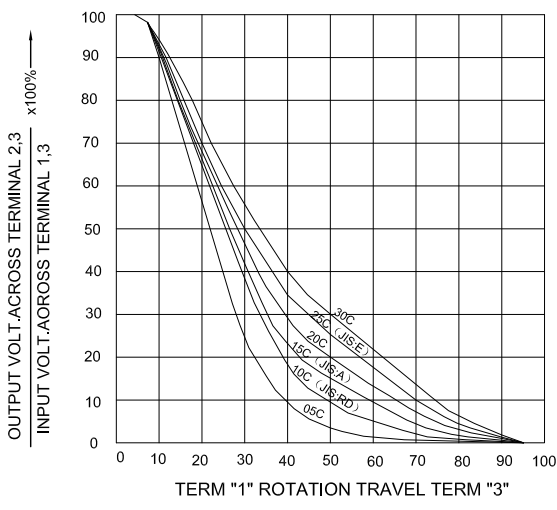

TAPER M & N SERIES

