

外形图 Mechanical Dimensions

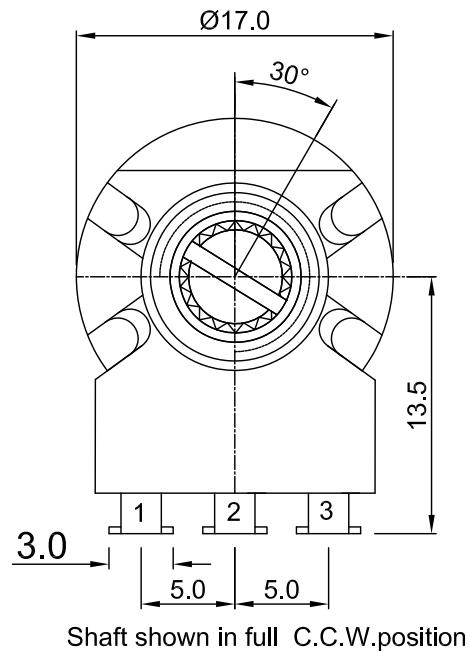

接线图 Circuit explanation

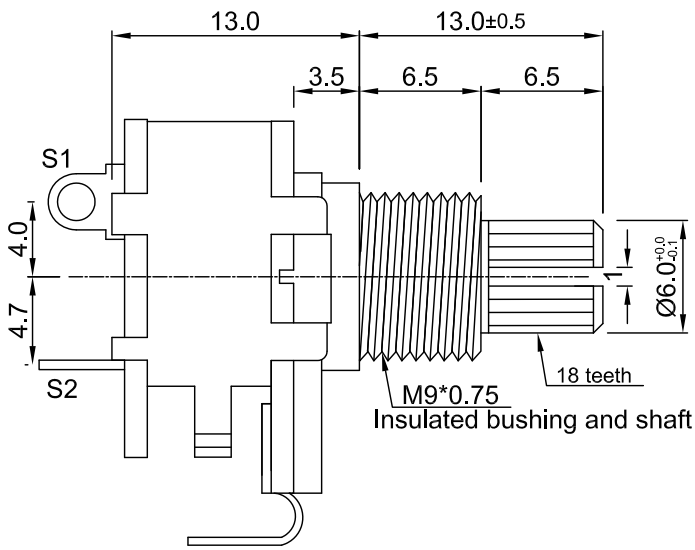
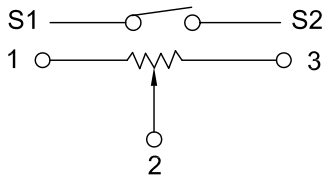

安装孔位置图 P.C.B. mounting hole detail

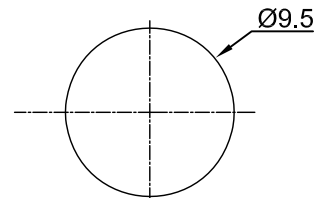

Attached parts : nut & washer

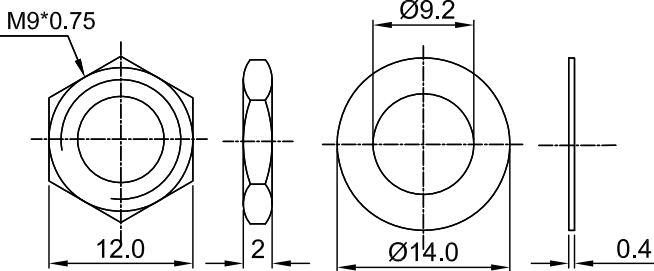

3				PRODUCT NAME	Rotary Potentiometer		
2				MODEL NAME	R1615S-13KQB1-value		
1				APPROVED BY	CHECKED BY	DRAWN BY	
NO	DATE	DESCRIPTION		<div style="border: 1px solid black; border-radius: 50%; width: 60px; height: 60px; margin: 0 auto; display: flex; flex-direction: column; justify-content: center; align-items: center;"> R & D 2014/3/6 Eva </div>	<div style="border: 1px solid black; border-radius: 50%; width: 60px; height: 60px; margin: 0 auto; display: flex; flex-direction: column; justify-content: center; align-items: center;"> R & D 2014/3/6 Sophie </div>	<div style="border: 1px solid black; border-radius: 50%; width: 60px; height: 60px; margin: 0 auto; display: flex; flex-direction: column; justify-content: center; align-items: center;"> R & D 2014/3/6 Ball </div>	
DIMENSION	TOLERANCE	SCALE	UNIT				mm
$\int \leq 10$	± 0.2	UNIT	mm				
$10 < \int \leq 30$	± 0.5	VER.	A0				
$30 < \int \leq 100$	± 1.0	DATE	2014/3/6				
All Angles	$\pm 5^\circ$						

16 mm Rotary Potentiometers with SW series Specifications

1. 電氣性能 (Electrical Characteristics)					
1.1	全阻抗值 (Total Resistance)		1K Ω ~ 2M Ω		
1.2	全阻抗值允許偏差 (Total Resistance Tolerance)		$\pm 20\%$ (More than 1 M Ω $\pm 30\%$)		
1.3	電阻隨溫度變化特性 (Resistance of temperature change character)		20 $^{\circ}$ C-75 $^{\circ}$ C: $\Delta R/R \leq \pm 5\%$, -25 $^{\circ}$ C-20 $^{\circ}$ C: $\Delta R/R \leq \pm 4.5\%$		
1.4	阻值變化特性 (Resistance Taper)		A, B, C, W		
1.5	零位阻值 (Residual Resistance)		R $\geq 250K\Omega$ / 0.1 % max. of total Value 250K Ω >R>10K Ω / 20 Ω max. 10K Ω \geq R / 10 Ω max.		
1.6	額定功率 (Rated Power)		Linear Taper B: 0.2W Other Taper:0.1W		
1.7	最高使用電壓 (Max.Operating Voltage)		150VAC		
1.8	動雜音 (Rotational Noise)		Less Than 100mV		
1.9	絕緣阻抗 (Insulation Resistance)		More than 100M Ω at DC 500V		
1.10	耐電壓 (Withstand Voltage)		For 1 minute at: AC 500V		
1.11	開關額定功率(Switch Rated Power)		DV 12V , 1.0A max		
2. 機械性能 (Mechanical Characteristics)					
2.1	全回轉角度 (Rotation Angle)		300 $^{\circ}$ $\pm 5^{\circ}$		
2.2	旋轉力矩 (Rotation Torque)		20~200gf.cm		
2.3	軸的拉、押強度 (Pull-Push Strength)		8 Kgf.cm		
2.4	轉動止檔強度 (Rotational Stop-End Torque)		6 kgf.cm Min		
2.5	開關角度(Switch Working Angel)		50 $^{\circ}$ $\pm 10^{\circ}$		
2.6	開關力矩(Switch Working Torque)		50~150gf.cm		
2.7	旋轉定位數目 (Number of Detents(click))		-----		
2.8	焊錫耐熱性 (Resistance To Soldering Heat)		<u>260± 5</u> $^{\circ}$ C and less than <u>3</u> seconds		
3. 耐久性能 (Durability)					
3.1	回轉壽命 (Rotation Life)		10,000 Cycles min.		
3.2	工作溫度 (Operating temperature)		-10 $^{\circ}$ C~+70 $^{\circ}$ C		
4.1	外形尺寸圖/曲線特性圖 (Shape size drawing/curve characteristic drawing)		見附頁 Please refer the drawing		
批 准		審 核		設 計	

RESISTANCE TAPER

TAPER B SERIES

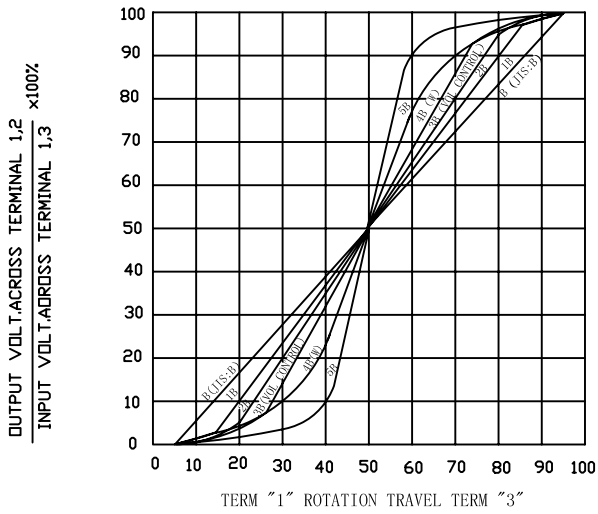

TAPER B WITH 50% TAP

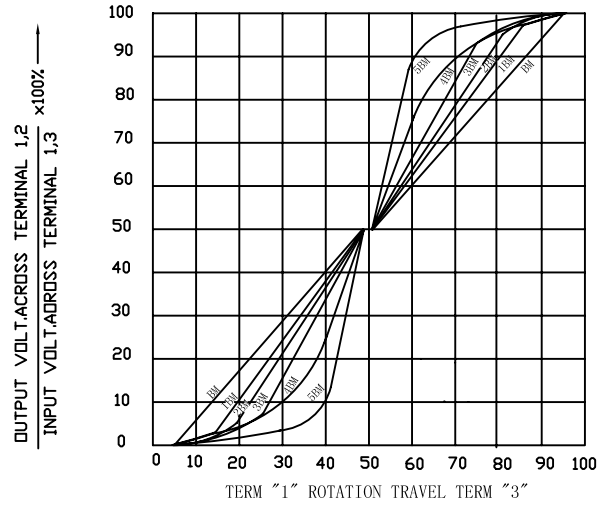

TAPER A SERIES

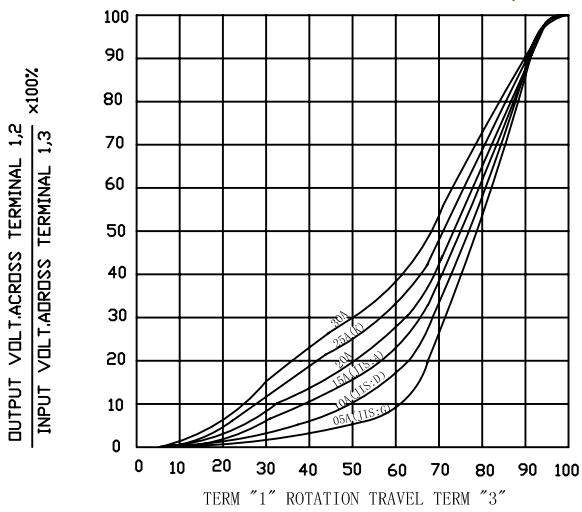

TAPER A & C WITH 50% TAP

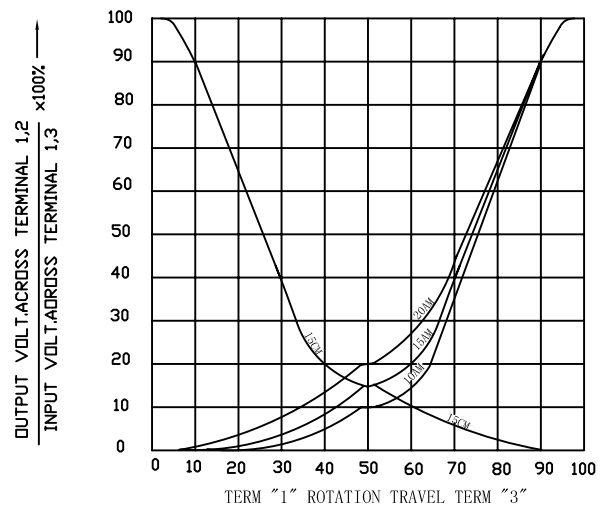

TAPER C SERIES

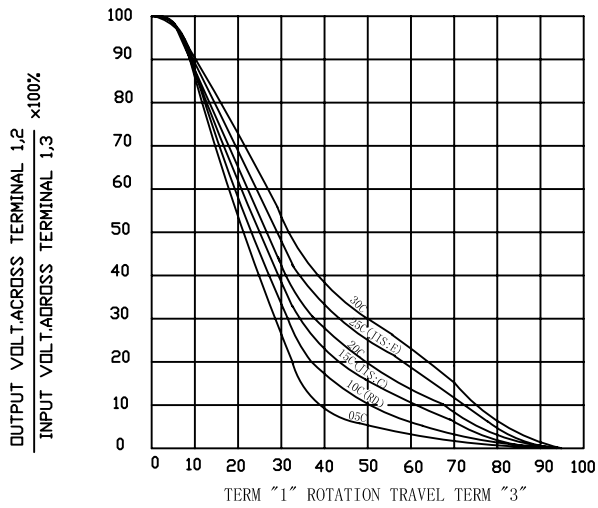

TAPER M & N SERIES

