

外形图 Mechanical Dimensions

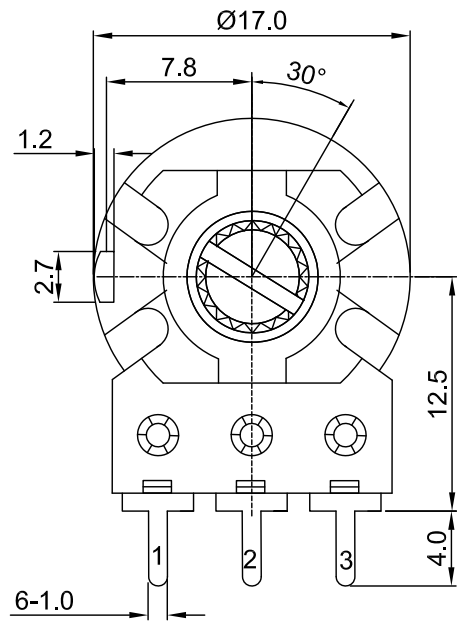

Shaft shown in full C.C.W. position

接线图
Circuit explanation

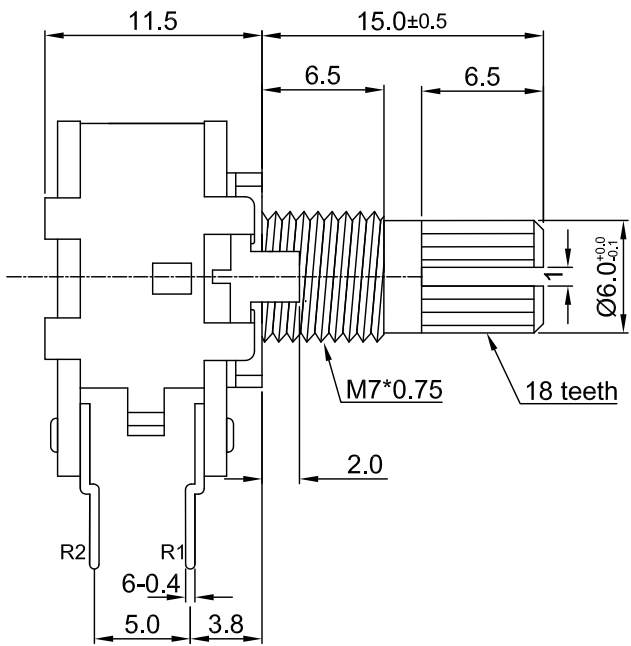
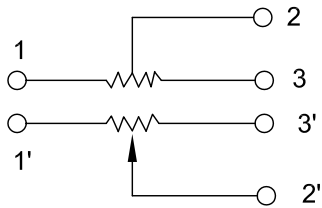

安装孔位置图
P.C.B. mounting hole detail

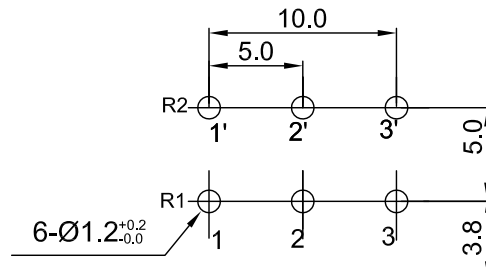

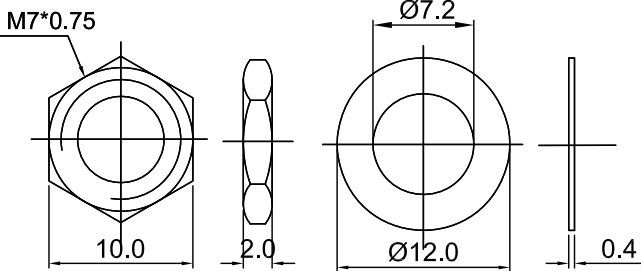

Attached parts : nut & washer



3				PRODUCT NAME	Rotary Potentiometer		
2				MODEL NAME	RD1610G-2A1-value		
1				APPROVED BY	CHECKED BY	DRAWN BY	
NO	DATE	DESCRIPTION		<div style="border: 1px solid black; border-radius: 50%; width: 60px; height: 60px; margin: 0 auto; display: flex; flex-direction: column; justify-content: center; align-items: center;"> R & D 2014/3/6 Eva </div>	<div style="border: 1px solid black; border-radius: 50%; width: 60px; height: 60px; margin: 0 auto; display: flex; flex-direction: column; justify-content: center; align-items: center;"> R & D 2014/3/6 Sophie </div>	<div style="border: 1px solid black; border-radius: 50%; width: 60px; height: 60px; margin: 0 auto; display: flex; flex-direction: column; justify-content: center; align-items: center;"> R & D 2014/3/6 Ball </div>	
DIMENSION	TOLERANCE	SCALE	UNIT				mm
$f \leq 10$	± 0.2	UNIT	mm				
$10 < f \leq 30$	± 0.5	VER.	A0				
$30 < f \leq 100$	± 1.0	DATE	2014/3/6				
All Angles	$\pm 5^\circ$						

16 mm Rotary Potentiometers series Specifications

1. 電氣性能 (Electrical Characteristics)					
1.1	全阻抗值 (Total Resistance) 1KΩ ~ 2MΩ				
1.2	全阻抗值允許偏差 (Total Resistance Tolerance) ±20% (More than 1 M Ω ±30%)				
1.3	電阻隨溫度變化特性 Resistance of temperature change character) 20℃-75℃:ΔR/R≤±5%, -25℃-20℃:ΔR/R≤±4.5%				
1.4	阻值變化特性 (Resistance Taper) A, B , C, W				
1.5	零位阻值 (Residual Resistance) R>250KΩ / 0.1 % max. of total Value 250KΩ>R>10KΩ / 20Ω max. 10KΩ>R / 10Ω max.				
1.6	額定功率 (Rated Power) Linear Taper B: 0.2W Other Taper:0.1W				
1.7	最高使用電壓 (Max.Operating Voltage) 150V AC				
1.8	動雜音 (Rotational Noise) Less Than 100mV				
1.9	絕緣阻抗 (Insulation Resistance) More than 100MΩ at DC 500V				
1.10	耐電壓 (Withstand Voltage) For 1 minute at: AC 500V				
1.11	開關額定功率(Switch Rated Power) -----				
1.12	同步誤差 (Gang Error) 0dB~40dB ≤3dB				
2. 機械性能 (Mechanical Characteristics)					
2.1	全回轉角度 (Rotation Angle) 300°±10°				
2.2	旋轉力矩 (Rotation Torque) 20~150gf.cm				
2.3	軸的拉、押強度 (Pull-Push Strength) 6 Kgf.cm				
2.4	轉動止檔強度 (Rotational Stop-End Torque) 5 kgf.cm Min				
2.5	開關角度(Switch Working Angel) -----				
2.6	開關力矩(Switch Working Torque) -----				
2.7	旋轉定位數目 (Number of Detents(click) detent: 0 ; 1; 11; 21; 31; 41				
2.8	焊錫耐熱性 (Resistance To Soldering Heat) 260±5℃ and less than 3 seconds				
3. 耐久性能 (Durability)					
3.1	回轉壽命 (Rotation Life) 10,000 Cycles min.				
3.2	工作溫度 (Operating temperature) -10℃~+70℃				
4.1	外形尺寸圖/曲線特性圖 (Shape size drawing/curve characteristic drawing) 見附頁 Please refer the drawing				
批准		審核		設計	

RESISTANCE TAPER

TAPER B SERIES

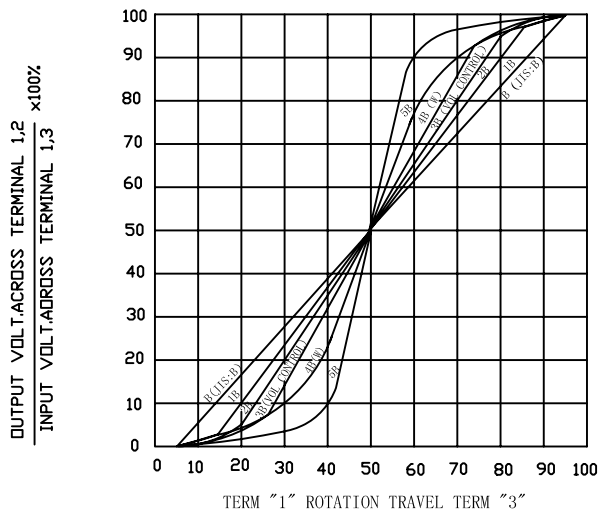

TAPER B WITH 50% TAP

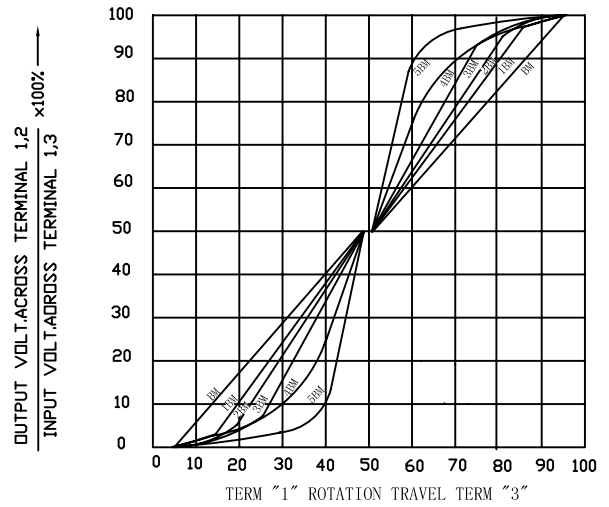

TAPER A SERIES

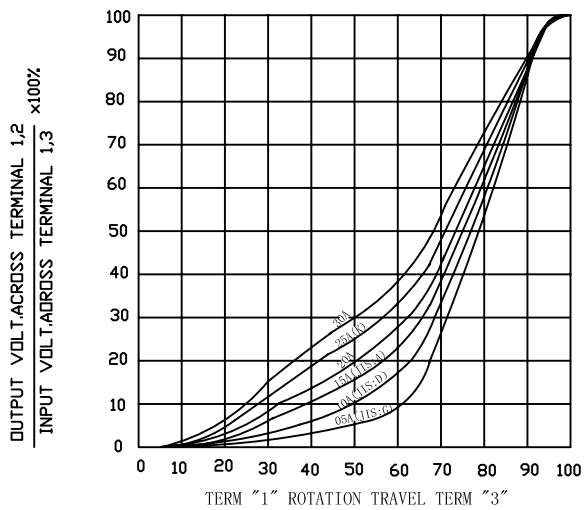

TAPER A & C WITH 50% TAP

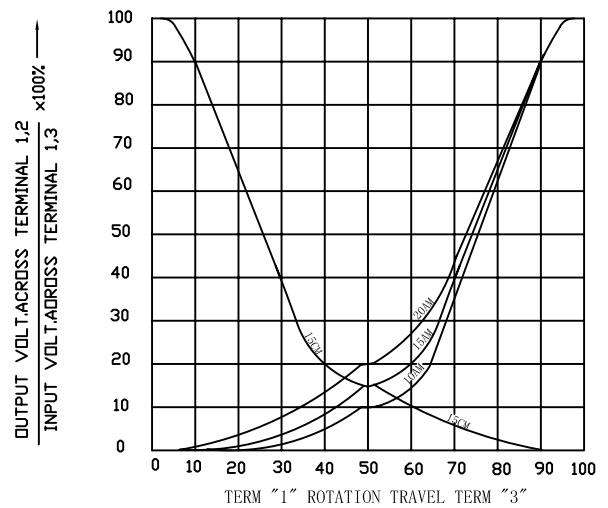

TAPER C SERIES

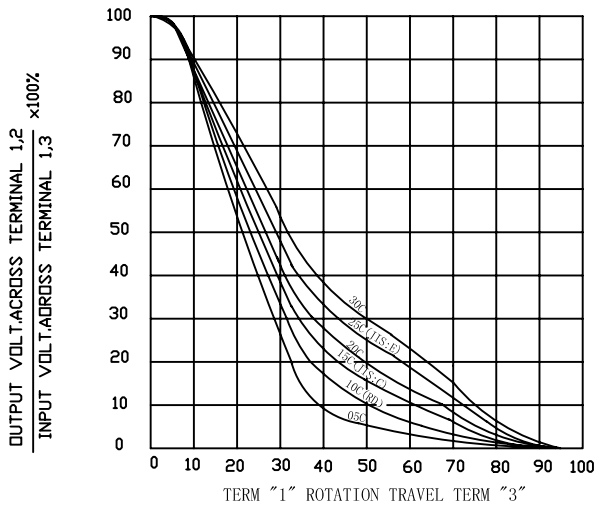

TAPER M & N SERIES

