

外形图 Mechanical Dimensions

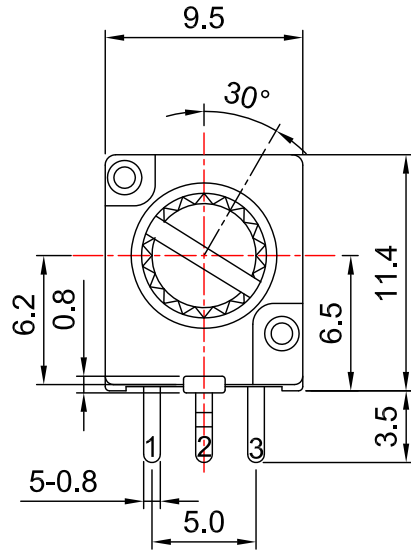

Shaft shown in full
C.C.W. position

接线图
Circuit Explanation

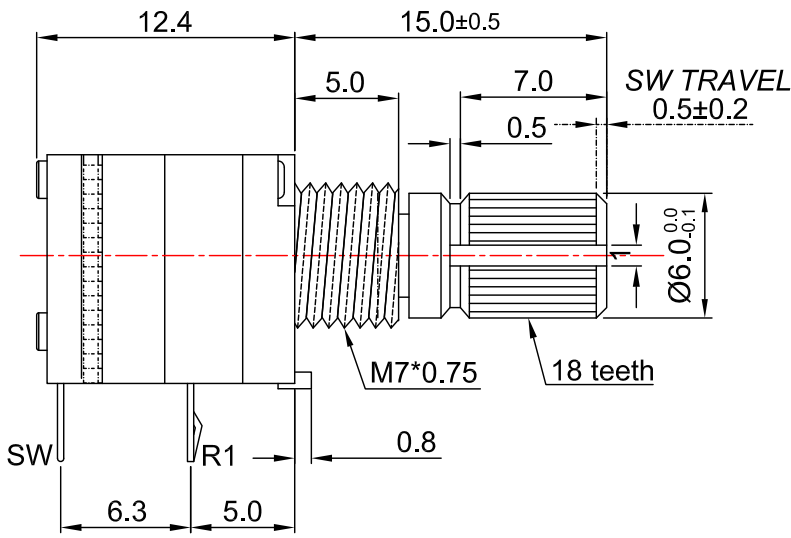
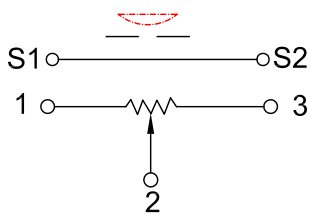

安装孔位置图
P.C.B. mounting hole detail

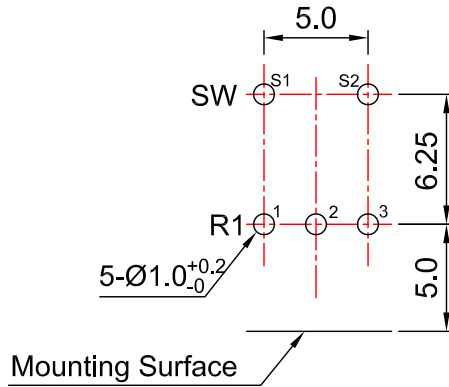

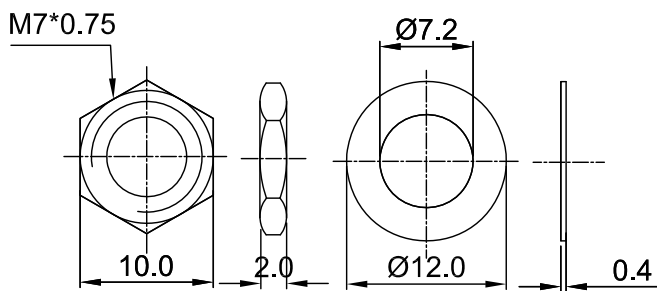

Attached parts: nut & washer



3				PRODUCT NAME	Rotary Potentiometer		
2				MODEL NAME	R0910PS-2A1-value		
1				APPROVED BY	CHECKED BY	DRAWN BY	
NO	DATE	DESCRIPTION					
		DIMENSION	TOLERANCE	SCALE			
		$\int \leq 10$	± 0.2	UNIT			mm
		$10 < \int \leq 30$	± 0.5	VER.			A0
		$30 < \int \leq 100$	± 1.0	DATE			2013/05/30
		All Angles	$\pm 5^\circ$				



9 mm Rotary Series Potentiometers with SW Specifications

1.電氣性能 (Electrical Characteristics)			
1.1	全阻抗值 (Total Resistance)	1KΩ ~ 2MΩ	
1.2	全阻抗值允許偏差 (Total Resistance Tolerance)	±20% (More than 1 M Ω ±30%)	
1.3	電阻隨溫度變化特性 Resistance of temperature change character)	20°C-75°C:ΔR/R≤±5%, -25°C-20°C:ΔR/R≤±4.5%	
1.4	阻值變化特性 (Resistance Taper)	A, B, C, W	
1.5	零位阻值 (Residual Resistance)	R≥250KΩ / 0.1 % max. of total Value 250KΩ>R>10KΩ / 20Ω max. 10KΩ≥R / 10Ω max.	
1.6	額定功率 (Rated Power)	Linear Taper B: 0.05W Other Taper:0.025W	
1.7	最高使用電壓 (Max.Operating Voltage)	50V AC	
1.8	動雜音 (Rotational Noise)	Less Than 100mV	
1.9	絕緣阻抗 (Insulation Resistance)	More than 100MΩ at DC 250V	
1.10	耐電壓 (Withstand Voltage)	For 1 minute at: AC 300V	
1.11	开关額定功率(Switch Rated Power)	DV 12V, 1.0 A max.	
1.12	同步誤差 (Gang Error)	-----	
2.機械性能 (Mechanical Characteristics)			
2.1	全回轉角度 (Rotation Angle)	300°±5°	
2.2	旋轉力矩 (Rotation Torque)	20~200gf.cm	
2.3	軸的拉、押強度 (Pull-Push Strength)	Pull 3Kgf.cm / Push 5 Kgf.cm	
2.4	轉動止檔強度 (Rotational Stop-End Torque)	3 kgf.cm Min	
2.5	开关角度/行程(Switch Working Angel/travel)	Rotary SW:50°max. Push SW:0.5mm	
2.6	开关力矩(Switch Working Torque)	50~350gf.cm	
2.7	旋轉定位數目 (Number of Detents(click))	detent: 0, centre, 11, 21, 31, 41	
2.8	焊錫耐熱性 (Resistance To Soldering Heat)	260±5°C and less than 3 seconds	
3.耐久性能 (Durability)			
3.1	回轉壽命 (Rotation Life)	10,000 Cycles min.	
3.2	工作溫度 (Operating temperature)	-10°C~+70°C	
4.1	外形尺寸圖/曲線特性圖 (Shape size drawing/curve characteristic drawing)	見附頁 Please refer the drawing	
批 准	 Eva	審 核  Sophie	設 計  Dick

RESISTANCE TAPER



TAPER B SERIES

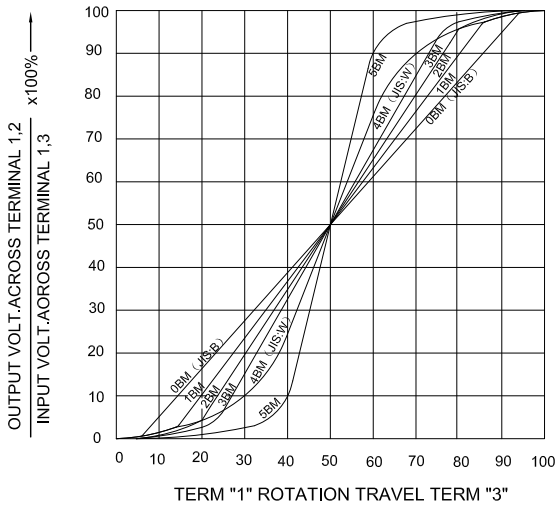

TAPER B WITH 50% TAP

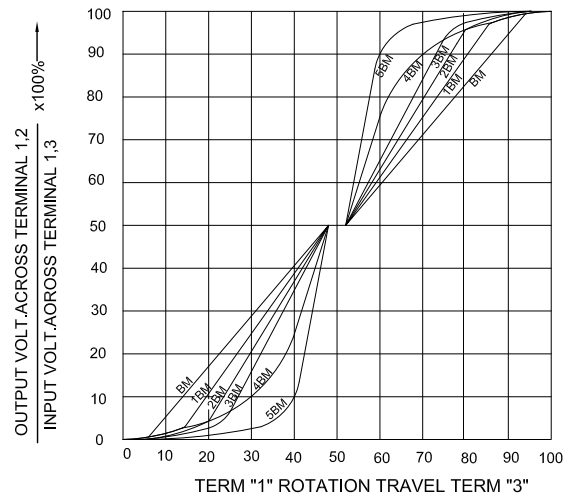

TAPER A SERIES

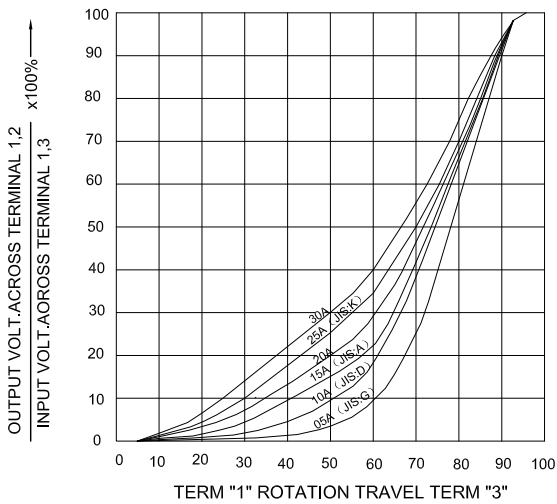

TAPER A & C WITH 50% TAP

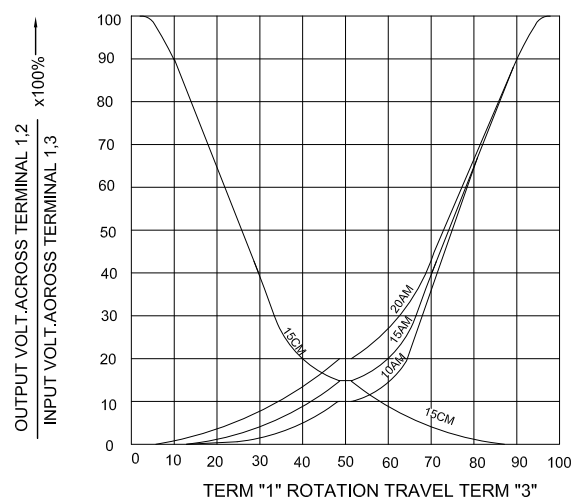

TAPER C SERIES

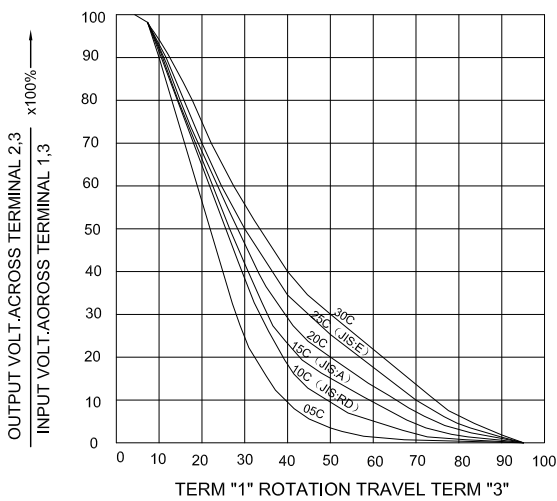

TAPER M & N SERIES

