

一、微調電阻系列技術規格書

Common Specification For Semi-Fixed Potentiometers

1. 電器性能 (Electrical Characteristic)					
序号	項目			特性	
1.1	全阻抗值 (Total Resistance)			500 Ω ~ 2M	
1.2	全阻抗值允許偏差 (Total Resistance Tolerance)			± 20%	
1.3	電阻隨溫度變化特性 (Resistance of temperature Change character)			20°C ~ 75°C: $\Delta R/R \leq \pm 5\%$, -25°C ~ 20°C: $\Delta R/R \leq \pm 4.5\%$	
1.4	阻值變化特性 (Resistance Taper)			B	
1.5	零位阻值 (Residual Resistance)			R ≤ 10K 10 Ω Max R > 10K 1% Max.	
1.6	額定功率 (Rated Power)			0.5W	
1.7	最高使用電壓 (Max. Operating Voltage)			AC 100V	
1.8	動雜音 (Rotational Noise)			/	
1.11	潮濕環境下負載性能 (Load Life In Humidity)			20% Max 350 hours rated in 90% RH 40°C	
2. 機械性能 (Mechanical Characteristics)					
2.1	全回轉角度 (Rotation Angle)			250° ± 10°	
2.2	旋轉力矩 (Rotation Torque)			40 ~ 250gf. cm	
2.3	轉動止檔強度 (Rotational Stop-End Torque)			1kgf. cm. max	
2.4	焊錫耐熱性 (Resistance to soldering heat)			245 ± 5°C and less than 3 seconds	
3. 耐久性能 (Durability)					
3.1	回轉壽命 (Rotation Life)			± 5% Max. for 100 rotations	
4. 外形尺寸圖 / 曲線特性圖 (Shape size drawing / curve characteristic drawing)				見附頁 (Please see attachment)	
批 准		審 核		設 計	

外形圖 Mechanical Dimensions

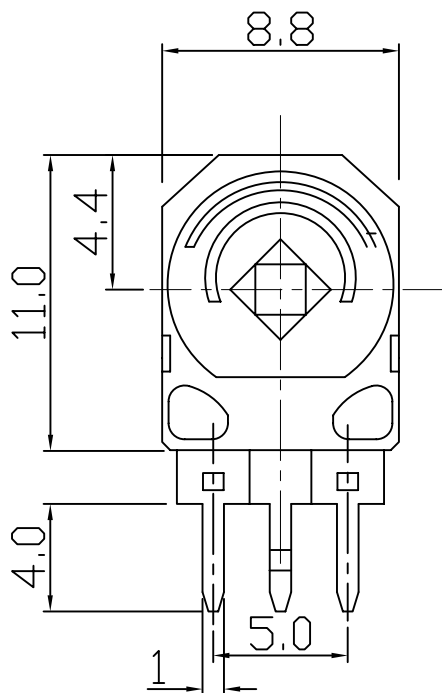

安裝孔位置圖
Mounting Hole

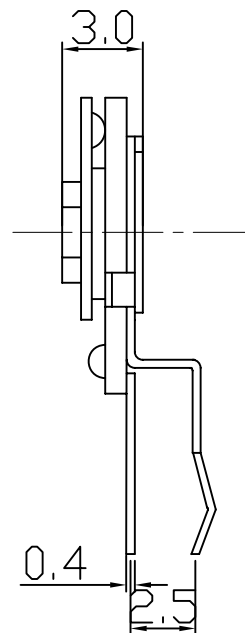
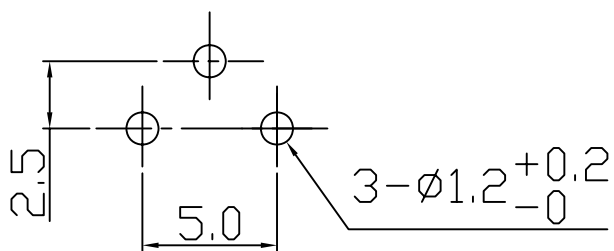

接線圖
Circuit Explanation

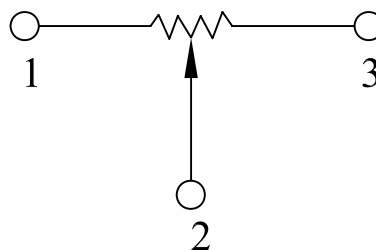

3			PRODUCT NAME		微调电阻		
2			MODEL NAME		SC083-3-Value		
1			APPROVED BY		CHECKED BY	DRAWN BY	
NO	DATE	DESCRIPTION		APPROVED BY	CHECKED BY	DRAWN BY	
		DIMENSION	TOLERANCE	SCALE	3:1		
		$l \leq 10$	± 0.2	UNIT	mm		
		$10 < l \leq 30$	± 0.5	VER.			
		$30 < l \leq 100$	± 1.0	DATE	07/06/03		

R & D
 2010.11.16
 Sam

RESISTANCE TAPER

TAPER B SERIES

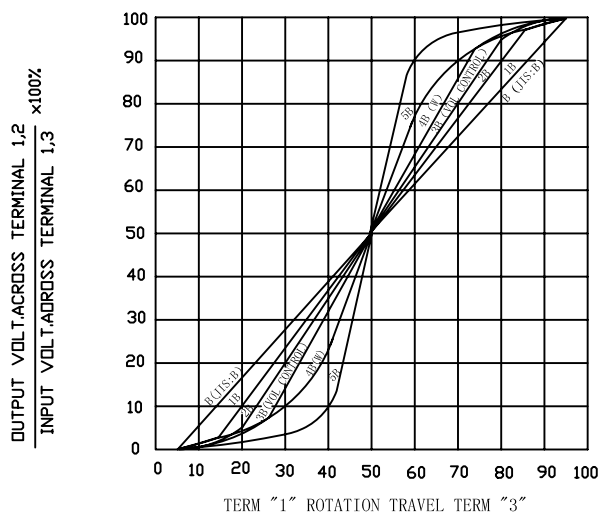

TAPER B WITH 50% TAP

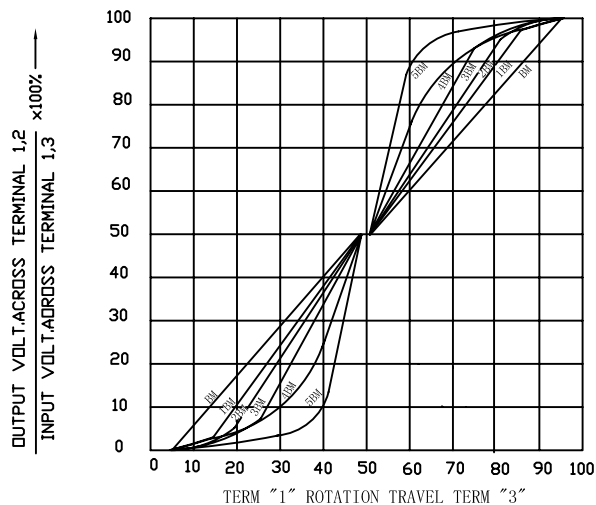

TAPER A SERIES

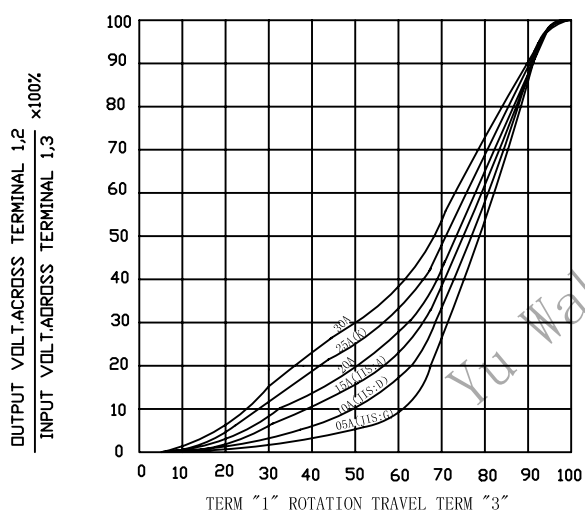

TAPER A & C WITH 50% TAP

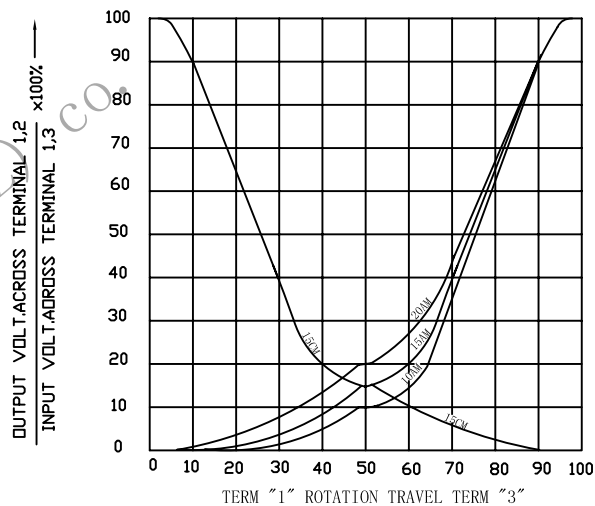

TAPER C SERIES

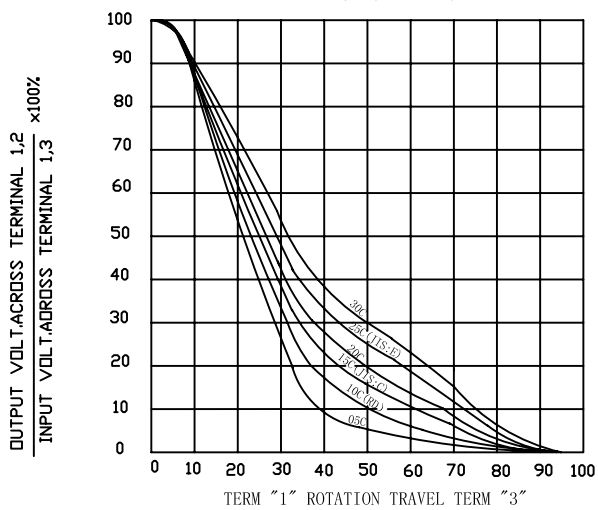

TAPER M & N SERIES

