



# Approval Sheet 承認書

編號: 10050393

Customer: 科诺尔  
客戶名稱: 科诺尔  
Our Parts No. \_\_\_\_\_  
本公司型號: SC063-A-5K  
Description: \_\_\_\_\_  
產品明細: 微调电阻

Pls Sign and fill and Return a copy to us after acceptable this Approval Sheet.  
樣品確認後, 請回簽一份回本公司存檔

(贵公司确认栏)

Approved No: 核准號:	_____
Remarks(備注):	_____
Your Parts No. 貴公司型號:	_____
Your Project No. 貴公司機種:	_____
Reviewed By(核對):	_____
Approval By(核准):	_____
Date(日期):	_____

**Yu Wah (HK) Co**

Rm.12, 1/F., Park Fook Ind. Building, 615-617 Tai Nam West St., Cheung Sha Wan, Hong Kong  
Tel : 852-2310 4311      Fax : 2371 3835      e-mail : sales@yuwah-vr.com

**裕华电子(东莞)公司**

中国, 广东省, 东莞市樟木头镇石新龙苑三巷七号  
电话: 0769-8718 7301      传真: 0769-8718 7303      电子邮件 : sales-cn@yuwah-vr.com

**裕华台湾总公司**

台湾, 桃园市, 复兴路20-1号9楼

**深圳裕华电子厂**

深圳市, 布吉镇, 下水径三街, 宝利源工业区二号厂房

# 一、微調電阻系列技術規格書

## Common Specification For Semi-Fixed Potentiometers

1. 電器性能 (Electrical Characteristic)					
序号	項目			特性	
1.1	全阻抗值 (Total Resistance)			5K $\Omega$	
1.2	全阻抗值允許偏差 (Total Resistance Tolerance)			$\pm 20\%$	
1.3	電阻隨溫度變化特性 (Resistance of temperature Change character)			20 $^{\circ}\text{C}$ ~75 $^{\circ}\text{C}$ : $\Delta R/R \leq \pm 5\%$ , -25 $^{\circ}\text{C}$ ~20 $^{\circ}\text{C}$ : $\Delta R/R \leq \pm 4.5\%$	
1.4	阻值變化特性 (Resistance Taper)			B	
1.5	零位阻值 (Residual Resistance)			R $\leq$ 10K 10 $\Omega$ Max R>10K 1%Max.	
1.6	額定功率 (Rated Power)			0.5W	
1.7	最高使用電壓 (Max. Operating Voltage)			AC 100V	
1.8	動雜音 (Rotational Noise)			/	
1.11	潮濕環境下負載性能 (Load Life In Humidity)			20%Max 350 hours rated in 90%RH 40 $^{\circ}\text{C}$	
2. 機械性能 (Mechanical Characteristics)					
2.1	全回轉角度 (Rotation Angle)			250 $^{\circ}$ $\pm$ 10 $^{\circ}$	
2.2	旋轉力矩 (Rotation Torque)			30~300gf. cm	
2.3	轉動止檔強度 (Rotational Stop-End Torque)			0.5Kgf. cm. max	
2.4	焊錫耐熱性 (Resistance to soldering heat)			245 $\pm$ 5 $^{\circ}\text{C}$ and less than 3 seconds	
3. 耐久性能 (Durability)					
3.1	回轉壽命 (Rotation Life)			$\pm 5\%$ Max. for 100 rotations	
4. 外形尺寸圖/曲線特性圖 (Shape size drawing/curve characteristic drawing)				見附頁 (Please see attachment)	
批 准			審 核		
				設 計	

外形圖  
Mechanical Dimensions

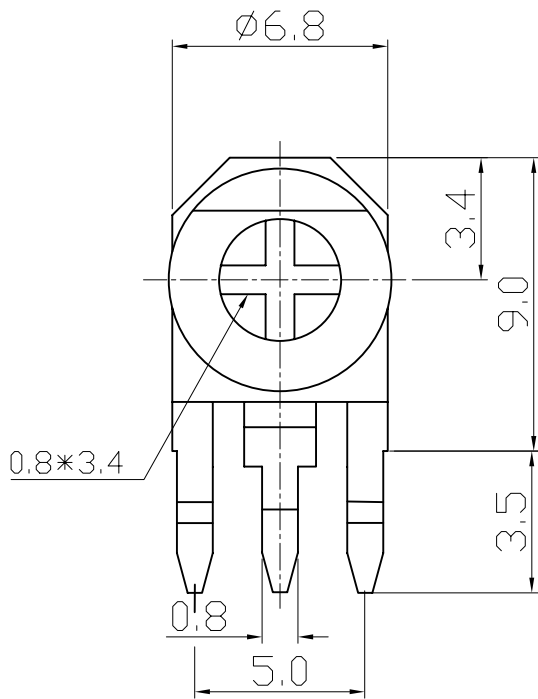

安裝孔位置圖  
Mounting Hole

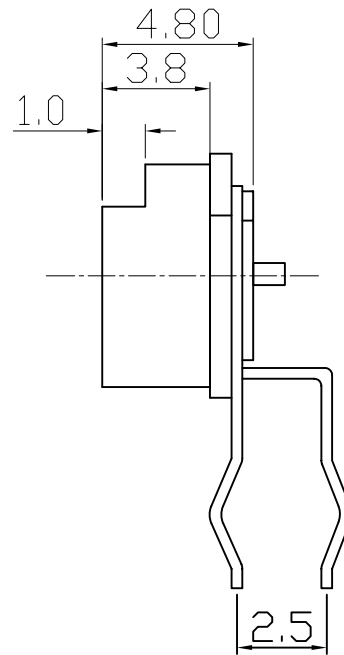

接線圖  
Circuit Explanation

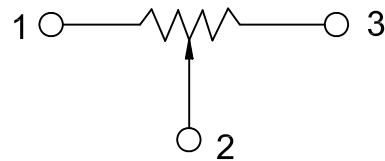
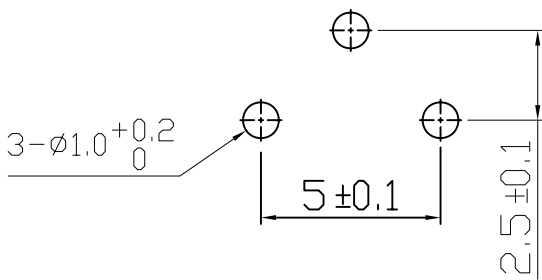

3				PRODUCT NAME	微调电阻		
2				MODEL NAME	SC063-A-5K		
1				APPROVED BY	CHECKED BY	DRAWN BY	
NO	DATE	DESCRIPTION					
		DIMENSION	TOLERANCE	SCALE			
		$l \leq 10$	$\pm 0.2$	UNIT			
		$10 < l \leq 30$	$\pm 0.5$	VER.			
		$30 < l \leq 100$	$\pm 1.0$	DATE			



YU WAH ( S Z ) CO., LTD

# RESISTANCE TAPER

TAPER B SERIES

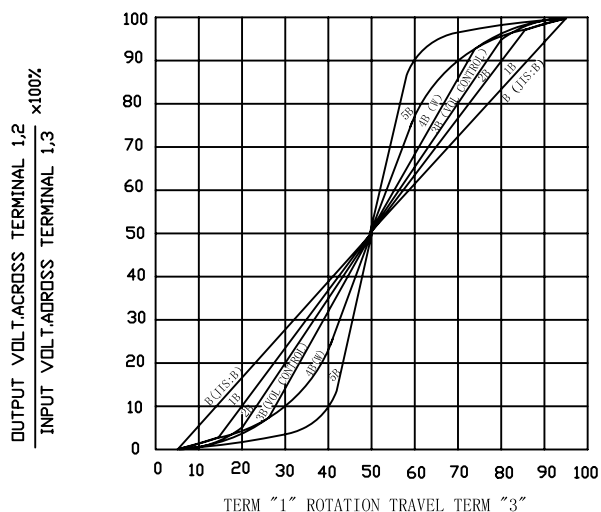

TAPER B WITH 50% TAP

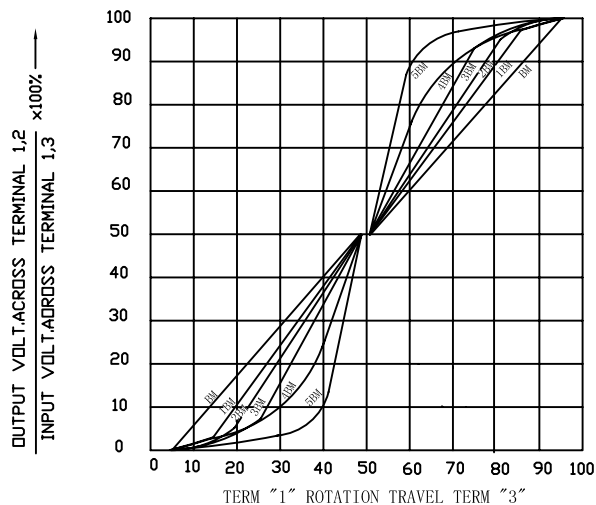

TAPER A SERIES

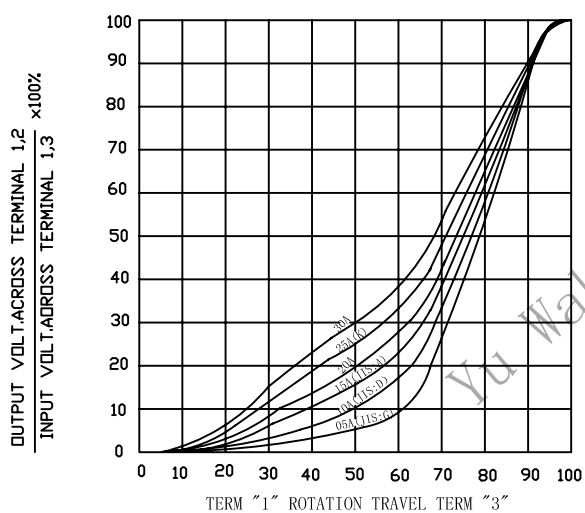

TAPER A & C WITH 50% TAP

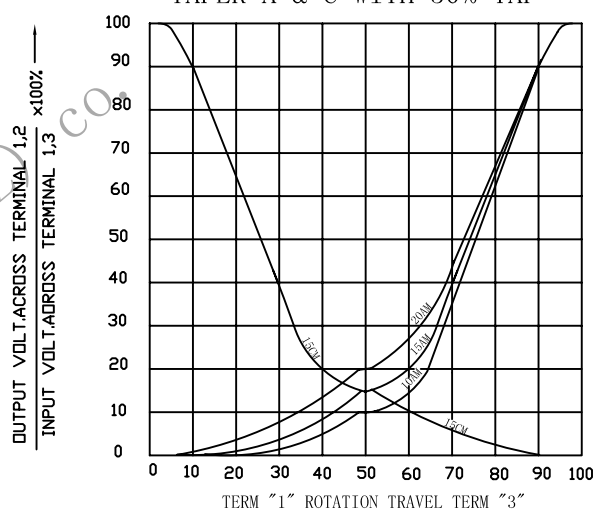

TAPER C SERIES

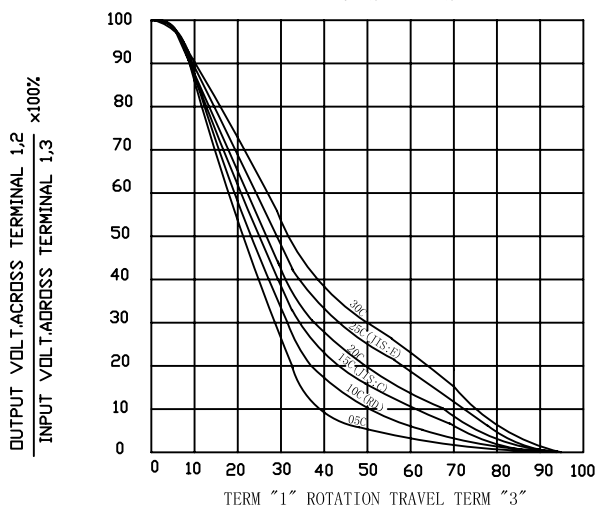

TAPER M & N SERIES

